







DERWENT

DRAWN TO PERFECTION

Derwent

Derwent House, Jubilee Road, Lillyhall Business Park Workington, Cumbria, CA14 4HS
Tel: 01900 609 590 Fax: 01900 602 489
Email: Derwent.Orders@acco.com

 www.twitter.com/derwentpencils  www.facebook.com/derwentartofficial
 www.youtube.com/derwentpencils  www.instagram.com/derwentpencils

www.DerwentArt.com

Item No: 2301924

 Oxford House,
Oxford Road, Aylesbury,
Buckinghamshire,
HP21 8SZ, England
Registered No: 197754
A division of ACCO UK Ltd.
An ACCO Brands Company

 **MADE IN
BRITAIN**



Front and back cover illustrations by Ian Fennelly

DERWENT

DRAWN TO PERFECTION

PRODUCT CATALOGUE 2019

 **MADE IN
BRITAIN**

DERWENT PROFESSIONAL QUALITY

FOR LEISURE ARTISTS, ART STUDENTS OVER 16, AND PROFESSIONAL ARTISTS

Consumer research clearly demonstrates that professional artists seek out the very best quality products to support their art practice. Derwent can justifiably claim to produce the most innovative and largest range of artists pencils, pens and accessories, ideal for the professional artist. Packaging and communications for the Derwent Professional range are appropriately confident and understated, leaving prospective consumers in no doubt if they are looking for professional quality art supplies to support their artistic ambitions.



DERWENT ACADEMY FOR ASPIRING ARTISTS

FOR SCHOOL AGE ARTISTS, 14+ YEARS OLD AND ENTRY LEVEL ADULT HOBBYISTS

Derwent Academy supports school age artists and entry level adult hobbyists on their artistic journey. The high quality product, packaging and communications reflect the changing aspirations of this audience; presenting a high quality, appealing proposition supporting consumers in reaching their goals.



DERWENT LAKELAND FOR CREATIVE CHILDREN

FOR JUNIOR ARTISTS, AGE 4-10 YEARS OLD

This is where the artistic journey begins for our very youngest artists, using colour pencils for the sheer joy of creating something, enabling them to begin to express themselves through art.

This entry-level category retains the legacy name of Lakeland to offer loyal customers the continuation of a familiar brand. The chosen colours, fonts and imagery also work together to clarify the intended audience.



DERWENT HERITAGE

With heritage dating back to 1832, Derwent's innovation comes from a deep understanding of the needs and requirements of artists. Perfecting the art of pencil manufacturing in the Lake District for generations, our wide range of pencils is synonymous with quality and craftsmanship. Artistry is threaded through the core of every Derwent product to deliver world class artists' materials at every stage of the creative journey.

MADE IN BRITAIN

Made in Britain promotes the products of British industry internationally and gives Derwent the opportunity to celebrate a long and distinguished heritage



BRAND HIERARCHY	2
PRODUCT HIERARCHY	4
PRODUCT MATRIX	6
SKETCHING & DRAWING PENCIL	12
Graphic Pencil	14
Precision Mechanical Pencil	16
Sketching Pencil	18
Onyx Pencil	19
Charcoal Pencil	20
Tinted Charcoal Pencil	22
COLOUR PENCIL	24
Lightfast Pencil	26
Procolour Pencil	28
Coloursoft Pencil	30
Metallic Pencil (NEW)	32
Artists Pencil	34
Studio Pencil	36
Drawing Pencil	38
Pastel Pencil	40
WATER-SOLUBLE PENCIL	42
Inktense Pencil	44
Watercolour Pencil	46
Graphitint Pencil	48
Water-soluble Sketching Pencil	50
Graphitone Pencil	51
BLOCKS	52
Inktense Blocks	54
XL Graphite Blocks	56
Natural Graphite Blocks	57
XL Charcoal Blocks	58
Compressed Charcoal Blocks	59
PENS	60
Line Maker Pens (NEW)	62
Paint Pens (NEW)	64
PAINTS	66
Inktense Paint Pan Travel Set (NEW)	68
ACCESSORIES	70
Paper	72
Sharpeners	74
Erasers	76
Brushes	78
Drawing Aids	80
Storage	82
GIFTING	84
Collection Tins	86
Wooden Boxes	88
Gifting Sets	90
ACADEMY	92
Academy Pencils	96
Academy Pastels	98
Academy Paints	100
Academy Markers	102
LAKELAND	104
OFFICE ESSENTIALS	108
MERCHANDISING	114
Free Standing Units	116
Point of Display Units	118
VIP Programme	120
Academy Merchandising	122

Derwent has a long history of innovation and new product development. This comes from a deep understanding of the needs of the artistic community. We aim to stay at the forefront, developing new solutions to every day creative problems as well as improving the way we service and support our customers.

No other competitor offers such specialist breadth across the range of pencils and associated products. This product hierarchy helps consumers understand the ranges according to a product's uniqueness.

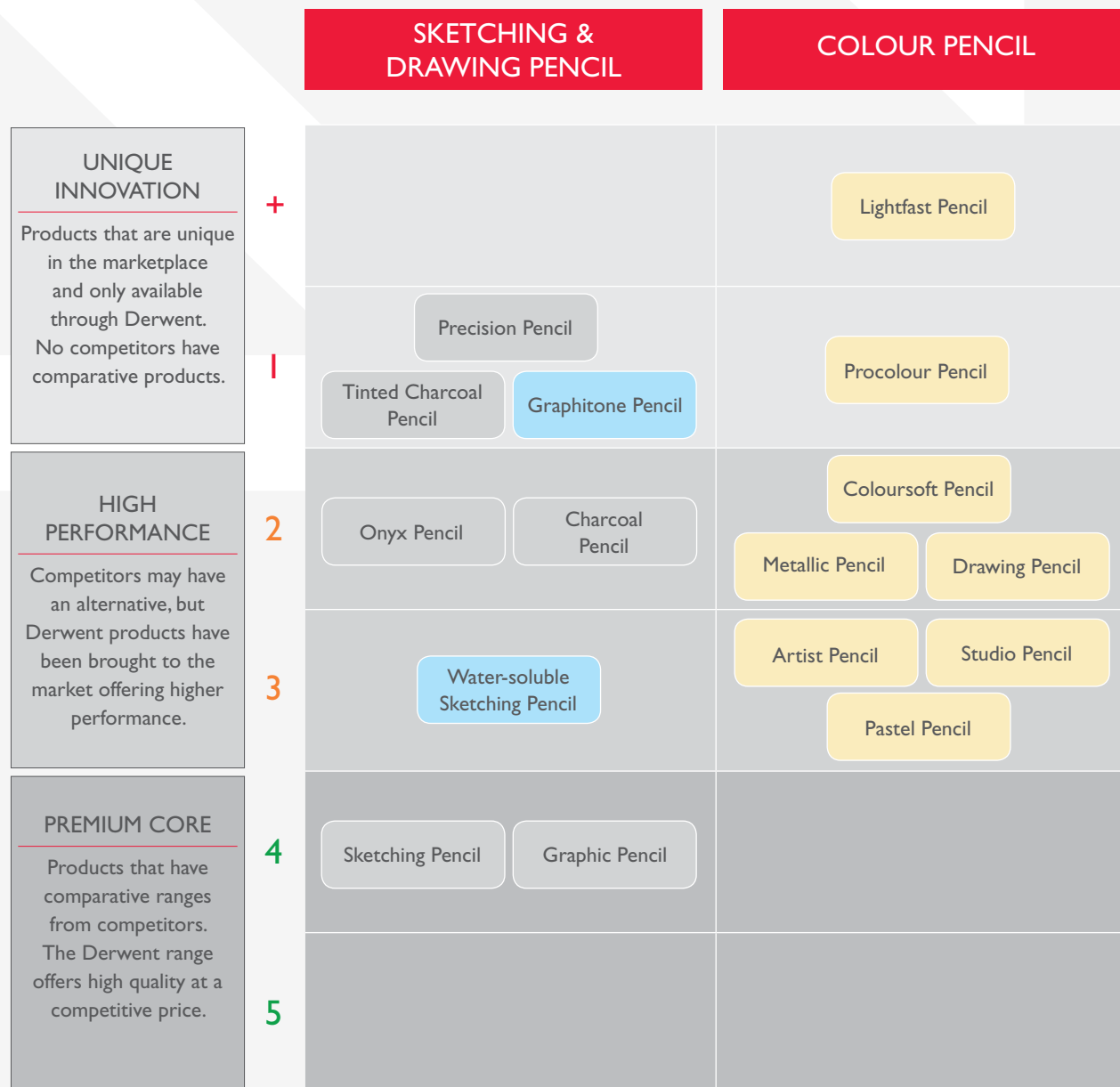

KEY:

- Water-soluble
- Naturally Water-soluble
- Non Water-soluble



SHOPPING THE RANGE

We have created an easy to use, at-a-glance matrix on how to shop the Derwent product range (Professional Quality). The guide is split into 5 product categories; Sketching & Drawing Pencil, Colour Pencil, Water-soluble Pencil, Blocks and Pens.

The most innovative features to Derwent within each category are listed to the left of the columns, highlighting the unique characteristics of the products. The guide is printed and used in an A4 format. Priced versions for all markets are available.

Elements of the matrix are used within the catalogue and in our online communications. The positioning statements for each range are listed at the top of each column and are reinforced in all our communications both online and offline.

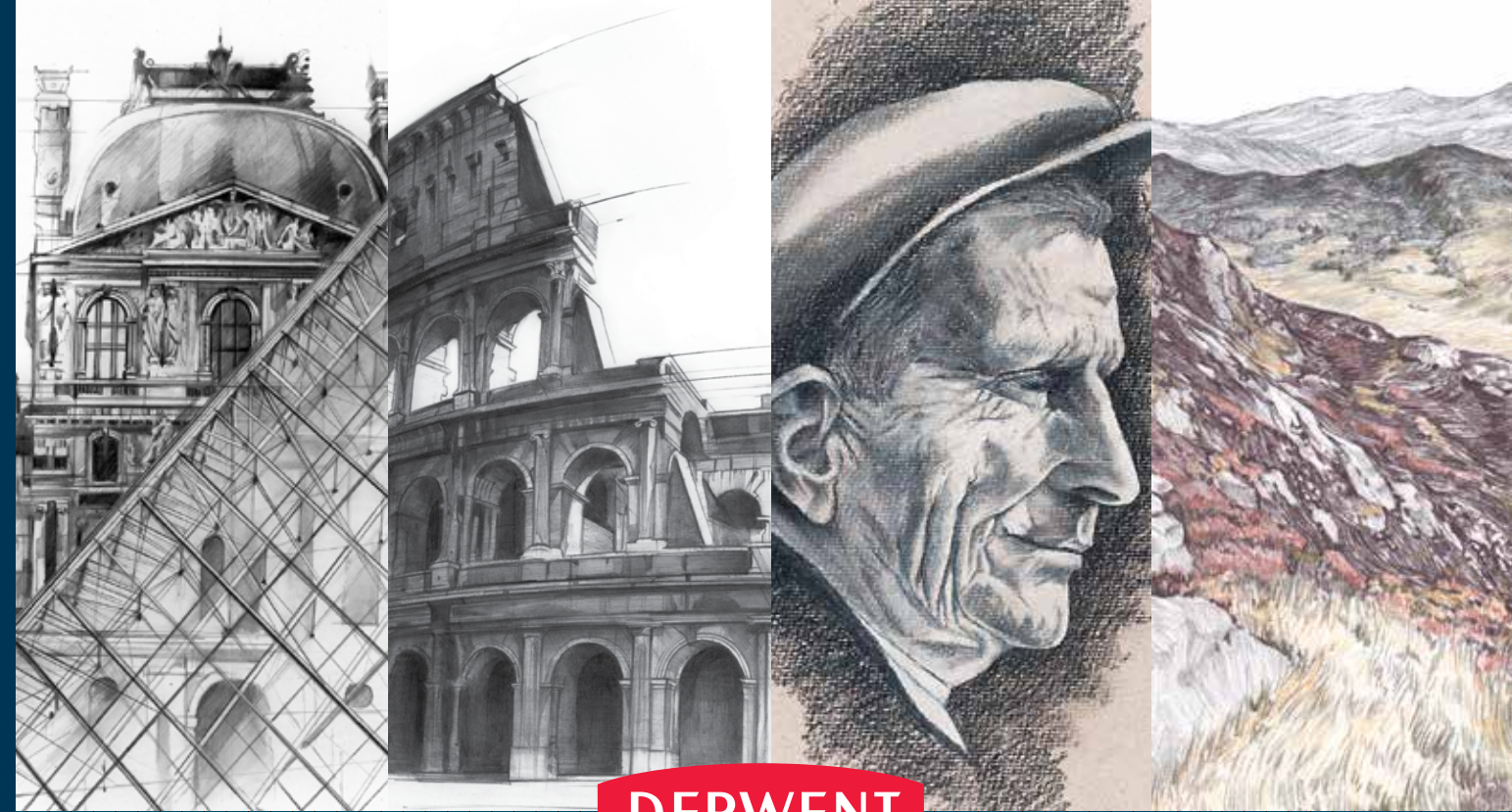

DERWENT

DRAWN TO PERFECTION

SKETCHING & DRAWING PENCIL



PRECISION GRAPHIC PENCILS SKETCHING PENCILS ONYX PENCILS CHARCOAL PENCILS TINTED CHARCOAL

	PRECISION	GRAPHIC PENCILS	SKETCHING PENCILS	ONYX PENCILS	CHARCOAL PENCILS	TINTED CHARCOAL
<p>Scale 0-5, where 5 is the most blendable, erasable etc.</p>						
SPECIFICATION						
Texture	Smooth	Smooth	Smooth	Smooth	Chalky	Chalky
Contains graphite	•	•	•	•		
Wax based		•	•	•		
Powder based					•	•
Naturally water-soluble	•	•	•	•	•	•
Core size*/barrel shape	0.5/0.7	2.2-3.5mm	4mm	4mm	4mm	4mm
Number of colours/degrees available	2	20	3	2	3	21
APPLICATION						
Fine detail	•	•	•	•	•	•
PERFORMANCE						
Lightfast**		100% of colours	100% of colours	100% of colours	100% of colours	100% of colours
Blendable (merging of colours)	•••••	•••••	•••••	•••••	•••••	•••••
Erasable	••••	•••••	••••	••••	••••	••••
Colour intensity						••
Layering*** (add depth, deepen or modify colours)	•••••	•••••	•••••	•••••	•••••	•••••
Point strength	••••	•••••	•••••	•••••	•••	•••

* Core size may vary by up to 10% ** Colours remain the same for 100 years under museum conditions *** Best performance over 12 layers



DERWENT

DRAWN TO PERFECTION

DERWENT

DRAWN TO PERFECTION

COLOUR PENCIL

	LIGHTFAST PENCILS	PROCOLOUR PENCILS	COLOURSOFT PENCILS	DRAWING PENCILS	ARTISTS PENCILS	STUDIO PENCILS	PASTEL PENCILS	METALLIC PENCILS
<p>Scale 0-5, where 5 is the most blendable, erasable etc.</p>	100% lightfast, oil-based coloured pencils.	Strong point, smooth laydown, minimal dusting.	Super soft and vibrant for swift colour build-up.	Earthy soft tones for lasting colour.	Firm point and extensive colour range for detailed work.	Enhanced control for detailed colour work.	Fine detail, minimum dust, easy blending.	Shimmering, highly metallic colour.
SPECIFICATION								
Texture	Creamy	Smooth	Soft	Creamy	Firm	Firm	Chalky	Soft
Oil based	•							
Wax based		•	•	•	•	•		•
Powder based							•	
Core size*/barrel shape	4 mm	4mm	4mm	5mm	4 mm	3.5 mm	4 mm	3.5 mm
Number of colours/degrees available	36	72	72	24	126	72	72	20
APPLICATION								
Use with oil painting mediums/solvents	•							
PERFORMANCE								
Lightfast**	100% of colours	72% of colours	88% of colours	100% of colours	79% of colours	66% of colours	87% of colours	
Blendable (merging of colours)	•••••	•••••	•••••	•••••	•••	•••	•••••	•••••
Erasable	•	••••	•	••	••	••	••••	••••
Colour intensity	•••••	•••••	•••••	•••••	•••	•••	••••	•••••
Layering*** (add depth, deepen or modify colours)	•••••	•••••	•••••	•••••	•••••	•••••	•••••	•••••
Point strength	••••	•••••	•••	••••	•••••	•••••	•••	••••

* Core size may vary by up to 10% ** Colours remain the same for 100 years under museum conditions *** Best performance over 12 layers

WATER-SOLUBLE PENCIL

	INKTENSE PENCILS	GRAPHITINT PENCILS	WATERCOLOUR PENCILS	WATER-SOLUBLE SKETCHING PENCILS	GRAPHITONE PENCILS
<p>Scale 0-5, where 5 is the most blendable, erasable etc.</p>	Vibrant and versatile colour. Permanent when dry.	Elegant coloured graphite. Water-soluble.	Softness and subtlety with watercolour flexibility.	Delicate graphite washes, easy to blend and layer.	Water-soluble sketching stick, quick coverage and multiple tones.
SPECIFICATION					
Texture	Firm	Smooth	Soft	Smooth	Smooth
Contains graphite		•		•	•
Wax based	•	•	•	•	•
Water-soluble	•	•	•	•	•
Permanent	Once dry				
Core size*/barrel shape	4mm	4mm	3.5 mm	4mm	4mm
Number of colours/degrees available	71 (+outliner)	24	72	3	4
APPLICATION					
Fine detail	•	•	•	•	•
Use on fabric (as well as paper)	•				
Use with fabric medium	•				
PERFORMANCE					
Lightfast**	87% of colours	100% of colours	80% of colours	100% of colours	100% of colours
Blendable (merging of colours)	•••	•••••	•••••	•••••	•••
Erasable		•••	••	•••••	••••
Colour intensity	•••••	•	•••		
Layering*** (add depth, deepen or modify colours)	••••	•••••	••••	•••••	•••••
Point strength	••••	••••	•••	•••••	••••

* Core size may vary by up to 10% ** Colours remain the same for 100 years under museum conditions *** Best performance over 12 layers

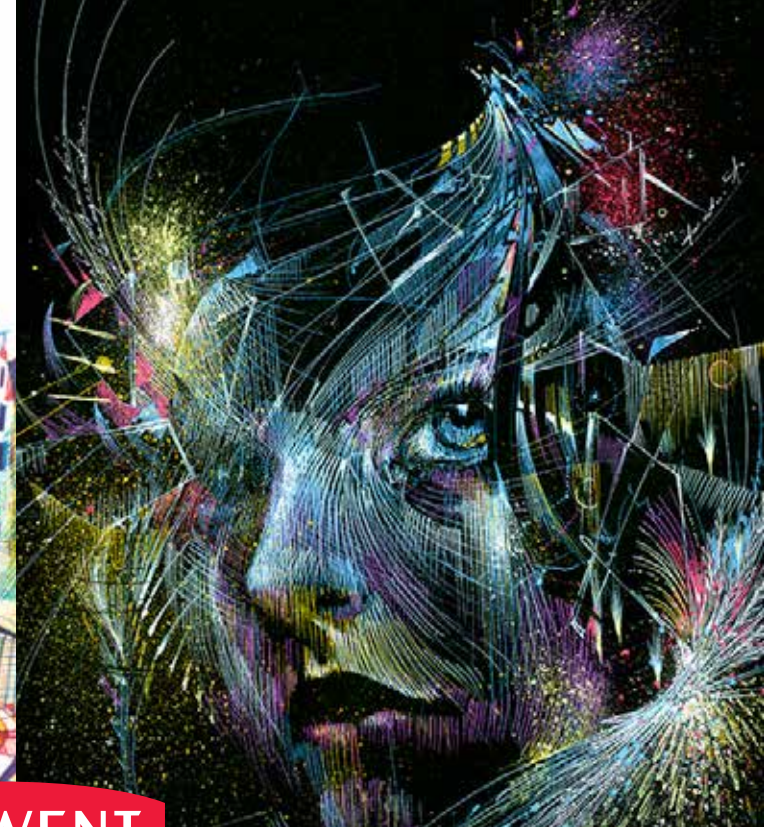
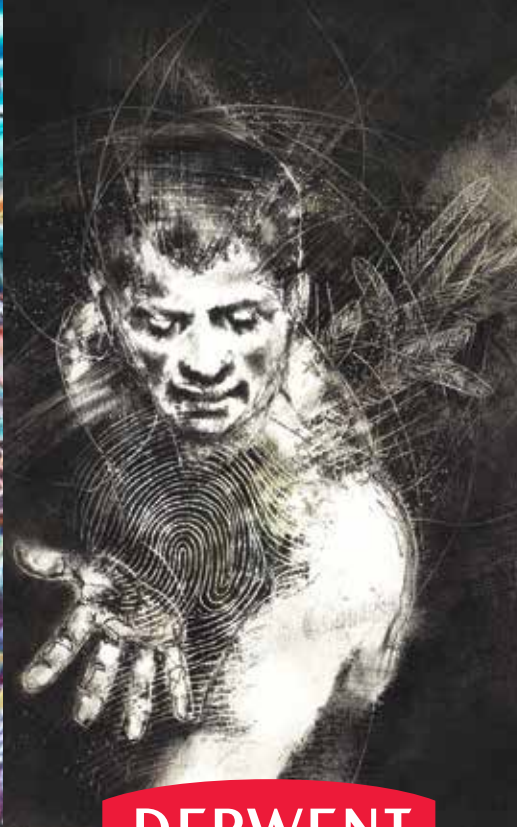

DERWENT

DRAWN TO PERFECTION

BLOCKS

			
	INKTENSE BLOCKS	XL BLOCKS GRAPHITE	XL BLOCKS CHARCOAL
 Scale 0-5, where 5 is the most blendable, erasable etc.	Vibrant and versatile colour. Permanent when dry.	Quick coverage for creative sketching.	Quick coverage for creative sketching.
SPECIFICATION			
Texture	Soft	Chalky	Chalky
Contains graphite		•	
Wax based	•		
Powder based		•	•
Water-soluble	•	•	•
Permanent	Once dry		
Core size*/barrel shape	 8mm	 20mm	 20mm
Number of colours/degrees available	72	6	6
APPLICATION			
Fine detail	•		
Use on fabric (as well as paper)	•		
PERFORMANCE			
Lightfast**	88% of colours	100% of colours	100% of colours
Blendable (merging of colours)	•••	•••••	•••••
Erasable		••••	••••
Colour intensity	•••••	••	••
Layering*** (add depth, deepen or modify colours)	••••	•••••	•••••
Strength	•••	•••	••••

* Core size may vary by up to 10% ** Colours remain the same for 100 years under museum conditions *** Best performance over 12 layers

DERWENT

DRAWN TO PERFECTION

PENS

		
	LINE MAKER PEN	PAINT PEN
 Scale 0-5, where 5 is the most blendable, erasable etc.	Superfine, free-flowing permanent liners.	Permanent, highly lightfast, opaque paint pens.
SPECIFICATION		
Type of ink	Water-based pigment ink	Water-based pigment ink
Solvent free	•	•
Permanent	Once dry	Once dry
Water-soluble		•
Nib size/barrel shape	 0.05 / 0.1 / 0.2 / 0.3 / 0.5 / 0.8mm	 0.5mm
Number of colours/degrees available	9 colours/6 nib sizes	20 colours/1 nib size
Unique in the market		•
APPLICATION		
Fine detail	•	•
Painting techniques		•
Use on fabric (as well as paper)		•
PERFORMANCE		
Lightfast**	78% of colours	85% of colours
Blendable (merging of colours)		•••••
Erasable		
Colour intensity	•••••	•••••
Layering*** (add depth, deepen or modify colours)	••••	•••••
Point strength	•••	•••

* Core size may vary by up to 10% ** Colours remain the same for 100 years under museum conditions *** Best performance over 12 layers

DERWENT

DRAWN TO PERFECTION

SKETCHING & DRAWING PENCILS



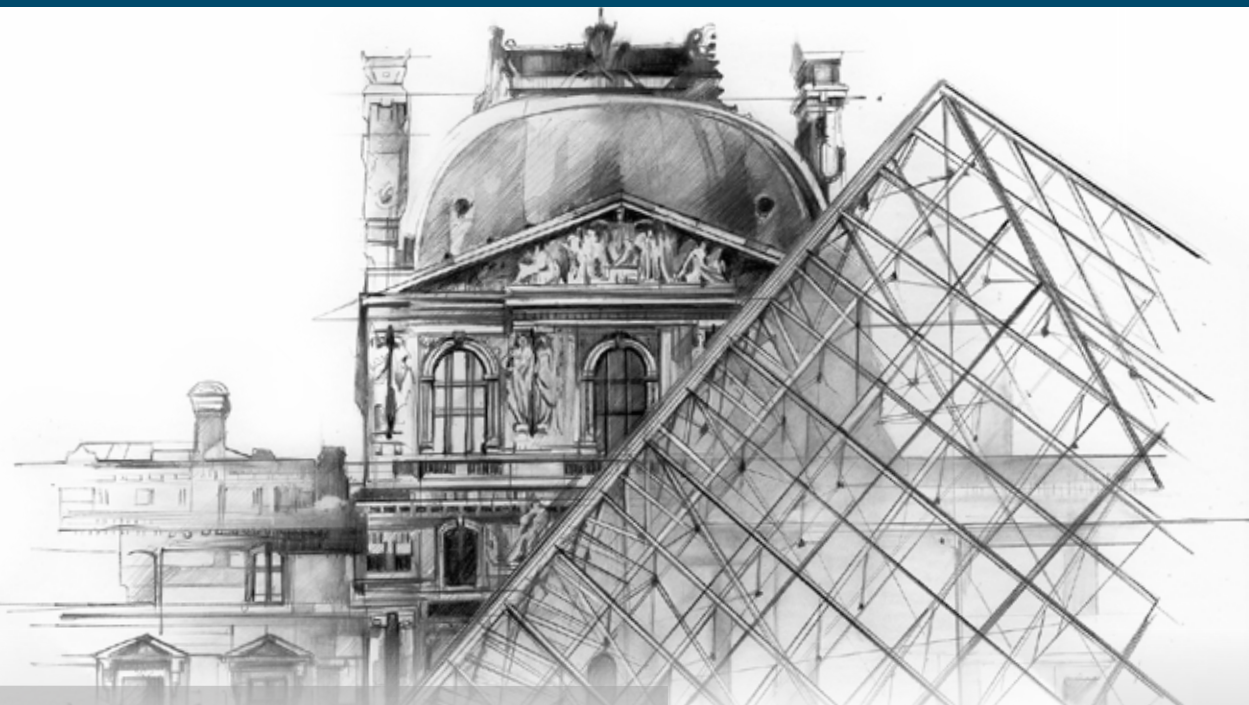

RANGE FEATURES

○ Texture	Smooth
○ Core size	0.5/0.7mm
○ No. degrees in range	2
○ Suitable for fine detail	○
○ Blendable	5
○ Erasable	4
○ Layering	5
○ Point strength	4
○ Premium metal barrel	●
○ Retractable pocket-safe nib	○
○ Rigorously tested graphite, to ensure the highest tensile strength across both the 0.5mm and 0.7mm grades	
○ Control and greater consistency, ensuring perfect laydown every time	
○ Elegant design and premium metal finish with a concealed push button eraser	
○ Available individually and in blisters and tins	

PRECISION
Mechanical precision, elegant metal barrel for balance and fine detail.

MECHANICAL PRECISION, ELEGANT METAL BARREL FOR BALANCE AND FINE DETAIL

Derwent Precision mechanical pencils have a premium full metal body, perfect for maintaining grip and balance. Ideal for sketching and drawing, the 0.5mm and 0.7mm sets contain 1 mechanical pencil, a refill pack of 15 HB leads and 3 replacement erasers. The graphite leads have a strong point for extended use and minimal breaking. Up to five leads can be placed into the pencil barrel at one time. The smooth laydown of graphite makes the pencil perfect for fine detail and cross hatching techniques. Refillable leads and erasers are available separately.



IVOR HARRISON

Derwent are renowned worldwide for manufacturing some of the finest graphite pencils artists can use. It goes without saying that the graphite cores and replacement cores of the Precision are of a high standard graphite that we have all come to know and love. With Derwent graphite, you know you're going to get reliability and quality in every pencil.

The metallic body of the Derwent Precision sports a stylish black gloss finish, trimmed with chrome nib, lapel clip and end cap, making the entire body an aesthetic beauty for anyone to carry.

Perhaps the most important feature of the Precision is the metal retractable sheath that extends with the click of the end cap, revealing the graphite. It's an important feature because so many mechanical pencils in this price range have static sheaths for the graphite. These tend to either break or rip clothing if the pencil is placed in a pocket. With the Derwent Precision, everything is tucked away beautifully when not in use meaning you can return to your pencil time and time again.

All I can say is thank you, Derwent, you have done it again, a wonderful product for artists, students, businessperson about the city or academics, the Derwent Precision fits them all.

ADELE WAGSTAFF

The Derwent Precision mechanical pencil is a very enjoyable drawing tool to use. When held in the hand it has a good weight and feels beautifully balanced when sketching. I found it incredibly responsive, giving delicate marks with the lightest of touches, and expressive, rhythmic flowing lines alongside fine, dark lines when further definition was needed. The fine lead was easy to load and its narrow point allowed for amazing precision when doing highly detailed work. It also enabled wonderful contrasts of light and dark, alongside both soft-edged and sharper-edged lines. I highly recommend this mechanical pencil as a drawing tool. It is ideal for students and professionals who are exploring expressive linear drawing, as well as those who work on very detailed pieces.

Derwent Precision is perfect to use for the subject of anatomical drawing because of its precise nature; expressive linear strokes and flowing marks needed to pick out structures and shapes.

STEPHEN LILLY

To get the feel of my new acquisition, I took some scrap paper and just scribbled and doodled for a while. Upon application I found the leads to be nice and strong, taking a fair amount of pressure and punishment. They also delivered a nice even application; some brands I have used in the past contain 'hard' particles that scratch the paper surface.

With a very pleasing weight and feel, the Derwent Precision cuts a very sleek and ergonomically designed figure, whilst giving artists the versatility they require.

As I usually work with a 0.5mm lead I was a little apprehensive having to use a slightly thicker lead. I need not have worried as it handled beautifully and was easy to sharpen to the finest of points for even more detail where required. The Precision was a joy to work with!

ARTIST RECOMMENDED ✓



PREMIUM METAL BARREL

RANGE FEATURES

○ Texture	Smooth
○ Wax-based	○
○ Core size	4mm
○ Round barrel	○
○ No. degrees in range	3
○ Lightfast*	100%
○ Blendable	5
○ Erasable	4
○ Layering	5
○ Point strength	5
○ Available individually and in blisters and tins	

*Lightfast, colours remain the same for 100 years under museum conditions

STRONG POINT FOR DRAWING AND SKETCHING

Sketching is all about being loose, free and easy, and Derwent Sketching pencils couldn't be easier to use; just 3 simple degrees HB, 2B and 4B, to cover all your sketching needs. They have a wide strip so you can quickly rough-out a loose sketch, or capture a passing cloud before it disappears! Once you've done that you can sharpen your pencil to a fine point to add the all important detail.

						BW
	34357	Sketching HB	●	●	V	8
	34358	Sketching 2B	●	●		8
	34359	Sketching 4B	●	●		8

● Blister of 4 ● Tin of 6

BW - Derwent Lightfast ratings are graded using the Blue Wool Scale, graded 0-8. 8 is the highest rating and values of 6 or more are considered to be lightfast.

V - Vegan friendly

RANGE FEATURES

○ Texture	Smooth
○ Wax-based	○
○ Core size	4mm
○ Round barrel	○
○ No. degrees in range	2
○ Lightfast*	100%
○ Blendable	5
○ Erasable	4
○ Layering	5
○ Point strength	5
○ Available individually and in blisters and tins	

*Lightfast, colours remain the same for 100 years under museum conditions

BUILD DEPTH WITH DRAMATICALLY DARK GRAPHITE

Derwent Onyx is our blackest graphite pencil; even darker than a 9B. Great on it's own, or add to work using other graphite media, like Graphic or Sketching pencils, to add dense shape and tone. Easy to build up darker shade by increasing pressure, and apply fine detail with a hard sharp point.

JUDITH SELCUK



Onyx pencils are the perfect balance of dark, strong graphite that enable me to achieve stunning deep shades whilst being able to sharpen to precision; particularly useful for detailed drawing when you need the extra depth. They compliment my graphite pencils perfectly and can also be used to add even more depth to my Graphitint drawings and sketches. A staple item for all art kits.

						BW
	2300038	Dark	●		V	8
	2300037	Medium	●			8

● Blister of 4 ● Tin of 6

BW - Derwent Lightfast ratings are graded using the Blue Wool Scale, graded 0-8. 8 is the highest rating and values of 6 or more are considered to be lightfast.

V - Vegan friendly



1.

2.

1.

2.

39003

MIXED MEDIA

6 DEGREES

0700663

MIXED MEDIA

6 DEGREES

0700836

FREE SHARPENER

6 DEGREES

2300038 Dark Onyx Pencil

2300037 Medium Onyx Pencil

Also available:

34345 Sketching 72 Tub

0700759 Sketching 48 Wooden Box

2301902 Sketching 72 Wooden Box

RANGE FEATURES

○ Texture	Chalky
○ Powder-based	○
○ Core size	4mm
○ Round barrel	○
○ No. degrees in range	3
○ Lightfast*	100%
○ Blendable	5
○ Erasable	4
○ Layering	5
○ Point strength	3
○ Available individually and in blisters and tins	

*Lightfast, colours remain the same for 100 years under museum conditions

CHARCOAL TONES FOR EVERYDAY USE

Often used for life studies, charcoal can be considered very traditional. But, encase it in wood and suddenly you have something much more contemporary - Derwent Charcoal pencils. They will give you great control over your drawings but keep all those traditional charcoal effects that you love, with less mess.

						BW
	36301	Charcoal Pencil Light	●	●	V	1
	36302	Charcoal Pencil Medium	●	●	V	2
	36303	Charcoal Pencil Dark	●	●	V	6

● Blister of 4 (also contains 1 x Tinted Charcoal White) ● Tin of 6 (contains 1 x Light, 2 x Medium, 2 x Dark, Tinted Charcoal White and a free sharpener)

BW - Derwent Lightfast ratings are graded using the Blue Wool Scale, graded 0-8. 8 is the highest rating and values of 6 or more are considered to be lightfast.

V - Vegan friendly

RANGE FEATURES

- 1 dark Charcoal Pencil for intense lines
- 2 Tinted Charcoal Pencils in Glowing Embers and White for some natural colour and highlights
- 2 Sticks of fine 4mm Natural Vine Charcoal for organic mark marking
- 1 Stick of 18mm Natural Chunky Willow Charcoal to make broad expressive strokes
- 1 Paper Stump for effective blending

MIXED CHARCOAL MEDIA

Perfect for life studies and expressive pieces; this charcoal collection has been specially selected to include a comprehensive range of charcoal media.



39000

4 DEGREES

0700838

6 DEGREES

0700664

6 DEGREES

2300675

8 DEGREES

Also available: 36300 Charcoal Pencil 72 Tub

DERWENT

DRAWN TO PERFECTION

COLOUR PENCILS





RANGE FEATURES

○ Texture	Creamy
○ Oil-based	○
○ Core size	4mm
○ No. colours in range	36
○ Suitable for use with painting mediums/solvents	○
○ Lightfast*	100%
○ Blendable	5
○ Erasable	1
○ Colour intensity	5
○ Layering	5
○ Point strength	4
○ Available individually and in tins	

LIGHTFAST PENCILS
100% lightfast, oil-based, coloured pencils.

100% LIGHTFAST OIL-BASED COLOURED PENCILS

Derwent Lightfast pencils have been formulated to be 100% lightfast. The revolutionary core is resistant to prolonged colour change ensuring artwork will not fade for up to 100 years under museum conditions. Its smooth oil base creates a rich vibrancy and can be mixed on the page to create a paint-like effect. Made from the finest raw materials and the purest pigments, all colours comply with internationally recognised lightfast testing standards ASTM D6901 and Blue Wool Scale ISO 105.

JESSE LANE



These lightfast pencils are Derwent's first oil-based pencils. The firmness of the lead is a good balance between soft and hard. It can make a fine point without breaking immediately, while still maintaining a bit of the smoothness of a creamy, soft pencil. The pencils themselves have a classy appearance with a varnished, bare wood. The neutral tone allows the coloured ends to stand out, making it easier to quickly locate colours while working. What I love about the Lightfast colour selection: there are colours that are almost, but not quite, black. I find this super helpful when creating shadow subjects fading in and out of shadow. I also enjoy the mid-tone colours for skin-tones.

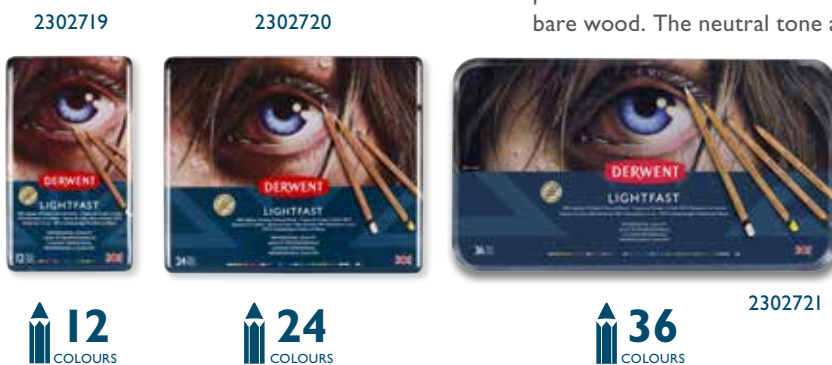

LAYERING

Oil-based coloured pencils offer great control over colour layering. See how multiple applications, and varying pressure, can produce different effects. This will be useful for bringing depth to your work. With the opaque laydown of Derwent Lightfast oil-based pencils, dark colours applied with the precision of a hard sharp point will sit over lighter shades for effective outlining and defining negative space.

MIXING

Over larger areas, layered colours will naturally mix. Rather than limiting your palette to the choices straight out of the tin, expand your colour range by tinting and mixing colours directly on the paper surface. This will create a more natural look to your work. See how pigments completely integrate to form a new and vibrant colour.

BLENDING

An oil-based binder offers unique blending properties. The thick core of Derwent Lightfast allows for dense and even colour application. Work the pigment into the tooth of the paper with lighter colours or a solvent medium to even out the application to create a painterly effect.

PRESSURE

Controlling the pressure of the pencil is vital for smooth colour application. Light pressure deposits a minimum amount of pigment to the paper and is ideal for the first colour of a layering sequence, rendering light or creating delicate shadings. Normal pressure provides good application of colour to render mid values and tones, backgrounds and finer detailing. Use heavy pressure for dense colour application when burnishing and creating dark values at the last stages of layering.

					LF ASTM D6901	
	2302648	Sun Yellow	●	●	V	I
	2302647	Champagne		●	V	I
	2302650	Yellow Ochre	●	●	V	I
	2302649	Sandstone	●	●	V	I
	2302661	Flesh Pink		●	V	I
	2302662	Salmon	●	●	V	I
	2302675	Sienna		●	V	I
	2302655	Scarlet	●	●	V	I
	2302707	Ruby Earth		●	V	I
	2302716	Oyster		●	V	I
	2302665	Heather		●	V	I
	2302668	Nightshade		●	V	I
	2302667	Violet	●	●	V	I
	2302669	Blue Violet		●	V	I
	2302670	Mid Ultramarine	●	●	V	I
	2302717	Arctic		●	V	I
	2302677	Dark Turquoise		●	V	I
	2302682	Mallard Green	●	●	V	I
	2302686	Racing Green		●	V	I
	2302684	Spruce Green		●	V	I
	2302692	Olive Earth		●	V	I
	2302713	Forest		●	V	I
	2302695	Seaweed		●	V	I
	2302696	Van Dyke Brown		●	V	I
	2302703	Venetian Red		●	V	I
	2302701	Sepia (Red)		●	V	I
	2302704	Natural Brown	●	●	V	I
	2302708	Chocolate		●	V	I
	2302698	Brown Ochre	●	●	V	I
	2302699	Wheat		●	V	I
	2302711	Warm Grey		●	V	I
	2302709	Cloud Grey		●	V	I
	2302710	Mist		●	V	I
	2302714	Midnight Black		●	V	I
	2302715	Black	●	●	V	I
	2302718	White	●	●	V	I

● Tin of 12 ● Tin of 24 ● Tin of 36
All colours comply with international lightfast testing standard ASTM D6901 and Blue Wool Scale ISO 105, V - Vegan friendly

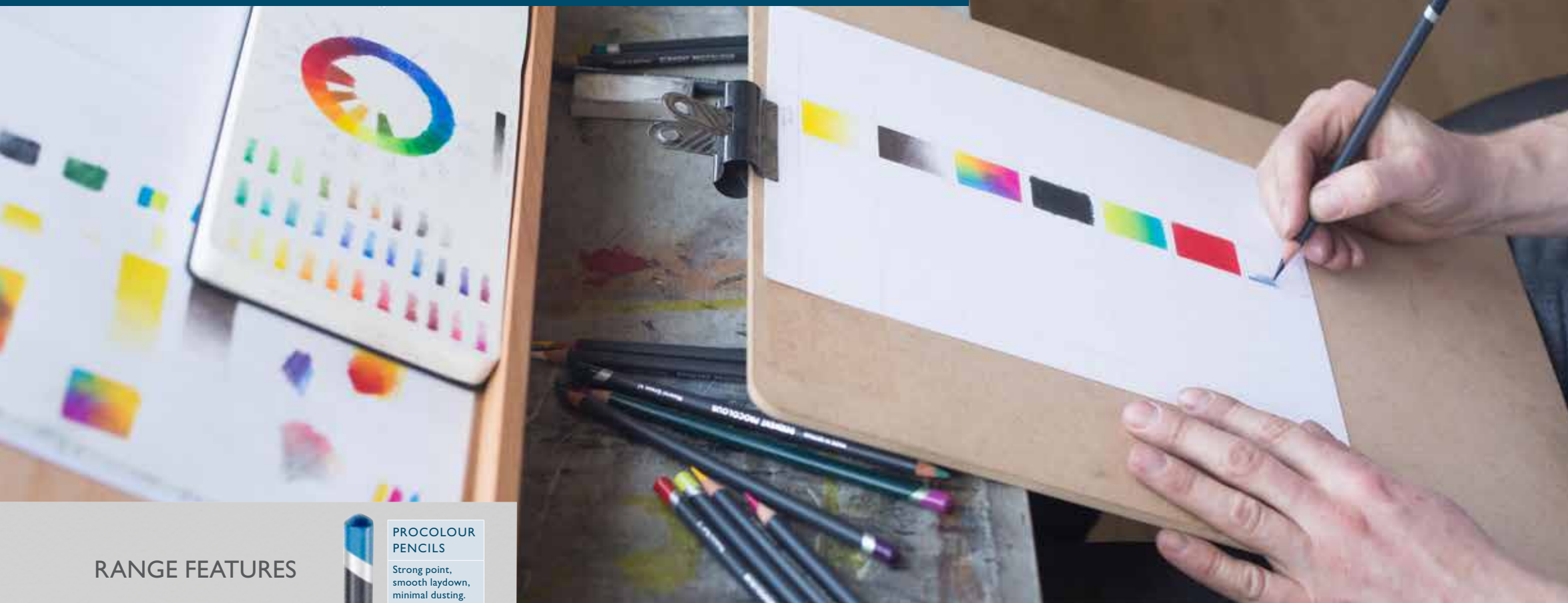

RANGE FEATURES

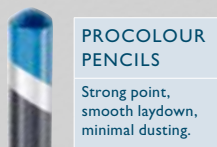

PROCOLOUR PENCILS

Strong point, smooth laydown, minimal dusting.

○ Texture	Smooth
○ Wax-based	○
○ Core size:	4mm
○ No. colours in range	72
○ Lightfast*	72%
○ Blendable	5
○ Erasable	4
○ Colour intensity	5
○ Layering	5
○ Point strength	5
○ Available individually and in tins and wooden boxes	

*Lightfast, colours remain the same for 100 years under museum conditions

STRONG POINT, SMOOTH LAYDOWN, MINIMAL DUSTING

Derwent Procolour pencils are the perfect combination of a strong point and smooth laydown, with a texture that has the covering power of a wax yet glides like an oil. The richly pigmented pencils maintain a sharp point for detailed drawing, while minimal chipping and dusting keeps your work clean and smudge free. Suitable for a wide range of drawing techniques, and available in a carefully selected range of 72 rich colours.

Also available:
2302523 Procolour 48 Wooden Box
2302524 Procolour 72 Wooden Box

JAKE SPICER



We all develop our own favourite colours in a range and repeatedly sharpening some pencils to stumps whilst others remain untouched. I'm going to predict that it won't be long until I'll need to return to shop for these four again...

Blue – not my usual pick of a favourite colour, the name is as delightful as the colour itself; a saturated mid-tone green-blue.

Nutmeg – it's rare to see such a rich, dark red-brown. It reminds me of dark autumn leaves after rain.

Geranium Lake – not so pale as other pinks it is still a little way away from being a brash bright red and gives rosy life to flesh tones.

Storm Grey – I love a good grey and I've been using this warm, near-neutral mid-tone for everything – even on its own as a graphite substitute.

2305584



12 COLOURS

2302505



12 COLOURS

2302506

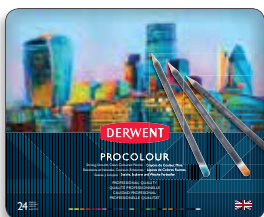

24 COLOURS

2302507



36 COLOURS

2302508



72 COLOURS

Colour	Code	Color Name	Tin of 12	Tin of 24	Tin of 36	Tin of 72	BW
2302433	01	Lime			●	●	V 5
2302434	02	Primrose Yellow	●	●	●	●	2/3
2302435	03	Buttercup Yellow	●	●	●	●	5
2302436	04	Champagne			●	●	8
2302437	05	Gold			●	●	7
2302438	06	Deep Cadmium			●	●	3/4
2302439	07	Yellow Ochre			●	●	8
2302440	08	Middle Chrome			●	●	5
2302441	09	Deep Chrome	●	●	●	●	6/7
2302442	10	Spectrum Orange			●	●	4
2302443	11	Bright Red			●	●	3
2302444	12	Primary Red	●	●	●	●	5
2302445	13	Geranium Lake			●	●	5
2302446	14	Crimson Lake		●	●	●	6
2302447	15	Plum			●	●	2
2302448	16	Flesh Pink			●	●	8
2302449	17	Salmon			●	●	8
2302450	18	Pink Madder Lake			●	●	3
2302451	19	Rose Pink			●	●	1
2302452	20	Cerise Pink	●	●	●	●	1
2302453	21	Magenta			●	●	1
2302454	22	Mars Violet			●	●	7
2302455	23	Heather		●	●	●	8
2302456	24	Soft Violet			●	●	8
2302457	25	Grape			●	●	4
2302458	26	Imperial Purple	●	●	●	●	3/4
2302459	27	Dark Violet			●	●	4/5
2302460	28	Blue Violet Lake			●	●	1
2302461	29	Delft Blue			●	●	5/6
2302462	30	Mid Ultramarine			●	●	8
2302463	31	Ultramarine			●	●	7
2302464	32	Prussian Blue	●	●	●	●	6
2302465	33	Phthalo Blue			●	●	7
2302466	34	Spectrum Blue	●	●	●	●	5
2302467	35	Dark Indigo			●	●	8
2302468	36	Cobalt Blue			●	●	5/6
2302469	37	Light Blue			●	●	3
2302470	38	Sky Blue			●	●	1
2302471	39	Kingfisher Blue			●	●	3
2302472	40	Midnight Blue		●	●	●	6
2302473	41	Turquoise Green			●	●	3
2302474	42	Spruce Green			●	●	6
2302475	43	Distant Green		●	●	●	6
2302476	44	Racing Green			●	●	8
2302477	45	Light Moss			●	●	5
2302478	46	Sap Green	●	●	●	●	5
2302479	47	Mineral Green			●	●	4
2302480	48	Cedar Green		●	●	●	5
2302481	49	Grass Green	●	●	●	●	6
2302482	50	Moss Green			●	●	5/6
2302483	51	Foliage		●	●	●	7/8
2302484	52	Olive Green			●	●	5
2302485	53	Bronze			●	●	8
2302486	54	Sepia			●	●	8
2302487	55	Burnt Umber	●	●	●	●	8
2302488	56	Vandyke Brown			●	●	7
2302489	57	Copper Beech			●	●	8
2302490	58	Chocolate			●	●	8
2302491	59	Brown Ochre	●	●	●	●	7
2302492	60	Burnt Yellow Ochre			●	●	7
2302493	61	Sunset Gold		●	●	●	8
2302494	62	Autumn Leaf			●	●	5
2302495	63	Venetian Red			●	●	7
2302496	64	Terracotta			●	●	6
2302497	65	Nutmeg		●	●	●	6
2302498	66	Burnt Carmine			●	●	3
2302499	67	Gunmetal		●	●	●	4
2302500	68	Storm Grey			●	●	8
2302501	69	Felt Grey			●	●	8
2302502	70	Blue Grey		●	●	●	4/5
2302503	71	Ivory Black	●	●	●	●	8
2302504	72	Chinese White		●	●	●	7

● Tin of 12 ● Tin of 24 ● Tin of 36 ● Tin of 72

BW - Derwent Lightfast ratings are graded using the Blue Wool Scale, graded 0-8. 8 is the highest rating and values of 6 or more are considered to be lightfast. V - Vegan friendly



RANGE FEATURES



METALLIC PENCILS

Shimmering, highly metallic colour.

○ Texture	Soft
○ Wax-based	○
○ Core size	3.5mm
○ Hexagonal barrel	○
○ No. colours in range	20
○ Blendable	5
○ Erasable	4
○ Colour intensity	5
○ Layering	5
○ Point strength	4
○ Available individually and in tins, cartons and blisters	

SHIMMERING, HIGHLY METALLIC COLOUR

Derwent Metallic pencils are shimmering, highly metallic pencils that blend beautifully together to create vivid and striking metallic effects, particularly on dark paper. With a new intense metallic formulation that heightens the appearance of the colour, the shimmering pigments and strong core produce brilliant definition and rich colour application. Suitable for a wide range of fine art and craft projects. Available in an extended range of 20 metallic colours, including eight new colours.

Also available:
 2305598 Metallic 20th Anniversary Set (20CT)
 2305625 Metallic Copper Ruler Set
 2305626 Metallic Copper Paperweight Set

JUDITH SELCUK



As a pencil artist I love the control the pencil can give, combining this with the beautiful metallic pigment takes my creativity to the next level. Metallic pencils allow me to easily create dynamic effects on black and toned paper which is something that can be difficult to achieve with regular pencils. Colours pop in this contemporary modern range with shades of gold and silver that you don't find anywhere else. Metallic pencils work equally well with the other pencil ranges, especially for highlights that shine and add dimension. A must have for any creative pencil artist.



	2305603	Silver	●	●	●			
	2305604	Pewter	●	●	●			
	2305605	Graphite	●					
	2305606	Copper	●	●	●			
	2305607	Bronze	●	●	●			
	2305608	Antique Gold	●	●	●			
	2305609	Gold	●	●	●			
	2305610	Yellow	●	●		●		
	2305611	Silver Mint	●				●	
	2305612	Turquoise	●					●
	2305613	Green	●	●		●		
	2305614	Blue	●	●		●		
	2305615	Ice Blue	●				●	
	2305616	Violet	●					●
	2305617	Purple	●	●		●		
	2305618	Silver Rose	●					●
	2305619	Pink	●	●		●		
	2305620	Red	●	●		●		
	2305621	Pink Gold	●					●
	2305622	Rose Gold	●					●

● 20th Anniversary Carton ● 12 Tin ● Traditional 6 Blister
 ● Colour 6 Blister ● Pastel 6 Blister



2305599



12 COLOURS

2305600



6 COLOURS

2305601



6 COLOURS

2305602



6 COLOURS

DERWENT

DRAWN TO PERFECTION

WATER-SOLUBLE PENCILS

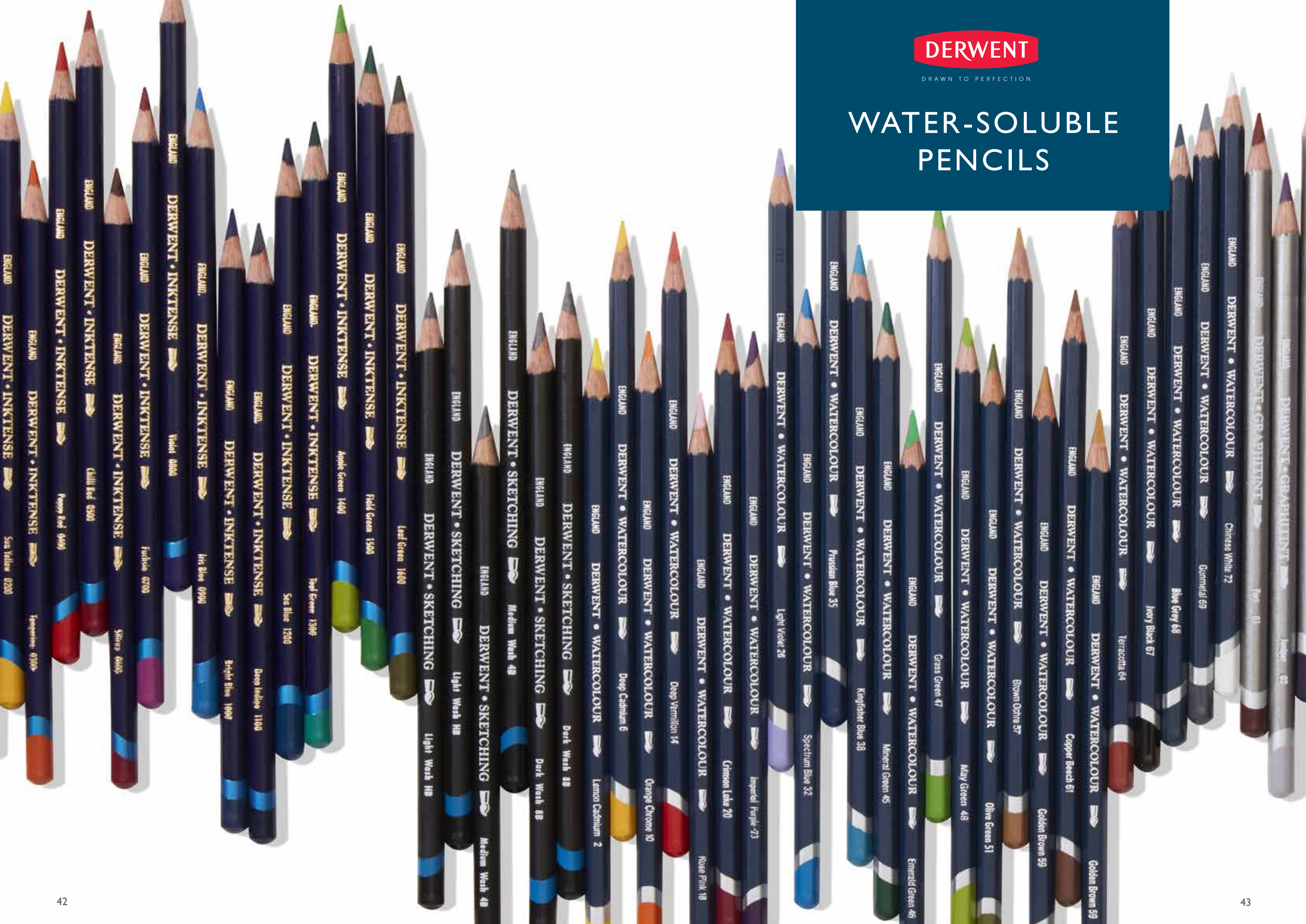

- ENGLAND DERWENT • INKTENSE Sun Yellow 0200
- ENGLAND DERWENT • INKTENSE Tangerine 0300
- ENGLAND DERWENT • INKTENSE Peppercorn 0400
- ENGLAND DERWENT • INKTENSE Chili Red 0500
- ENGLAND DERWENT • INKTENSE Saffron 0600
- ENGLAND DERWENT • INKTENSE Fuchsia 0700
- ENGLAND DERWENT • INKTENSE Violet 0800
- ENGLAND DERWENT • INKTENSE Iris Blue 0900
- ENGLAND DERWENT • INKTENSE Bright Blue 1000
- ENGLAND DERWENT • INKTENSE Deep Indigo 1100
- ENGLAND DERWENT • INKTENSE Sea Blue 1200
- ENGLAND DERWENT • INKTENSE Teal Green 1300
- ENGLAND DERWENT • INKTENSE Apple Green 1400
- ENGLAND DERWENT • INKTENSE Field Green 1500
- ENGLAND DERWENT • INKTENSE Leaf Green 1600
- ENGLAND DERWENT • SKETCHING Light Wash HB
- ENGLAND DERWENT • SKETCHING Light Wash HB
- ENGLAND DERWENT • SKETCHING Medium Wash 4B
- ENGLAND DERWENT • SKETCHING Dark Wash 8B
- ENGLAND DERWENT • SKETCHING Dark Wash 8B
- ENGLAND DERWENT • WATERCOLOUR Deep Cadmium 6
- ENGLAND DERWENT • WATERCOLOUR Lemon Cadmium 2
- ENGLAND DERWENT • WATERCOLOUR Orange Chrome 10
- ENGLAND DERWENT • WATERCOLOUR Rose Pink 18
- ENGLAND DERWENT • WATERCOLOUR Crimson Lake 20
- ENGLAND DERWENT • WATERCOLOUR Imperial Purple 23
- ENGLAND DERWENT • WATERCOLOUR Spectrum Blue 32
- ENGLAND DERWENT • WATERCOLOUR Prussian Blue 35
- ENGLAND DERWENT • WATERCOLOUR Kingfisher Blue 38
- ENGLAND DERWENT • WATERCOLOUR Mineral Green 45
- ENGLAND DERWENT • WATERCOLOUR Emerald Green 46
- ENGLAND DERWENT • WATERCOLOUR Grass Green 47
- ENGLAND DERWENT • WATERCOLOUR May Green 48
- ENGLAND DERWENT • WATERCOLOUR Olive Green 51
- ENGLAND DERWENT • WATERCOLOUR Brown Ochre 57
- ENGLAND DERWENT • WATERCOLOUR Golden Brown 59
- ENGLAND DERWENT • WATERCOLOUR Copper Beech 61
- ENGLAND DERWENT • WATERCOLOUR Terracotta 64
- ENGLAND DERWENT • WATERCOLOUR Ivory Black 67
- ENGLAND DERWENT • WATERCOLOUR Blue Grey 68
- ENGLAND DERWENT • WATERCOLOUR Gunmetal 69
- ENGLAND DERWENT • WATERCOLOUR Chinese White 72
- ENGLAND DERWENT • GRAPHITINT Grey 01
- ENGLAND DERWENT • GRAPHITINT Lead 03

RANGE FEATURES



GRAPHITINT PENCILS

Elegant coloured graphite. Water-soluble

○ Texture	Smooth
○ Wax-based (contains graphite)	○
○ Water-soluble	○
○ Core size	4mm
○ No. colours in range	24
○ Lightfast**	100%
○ Blendable	4
○ Erasable	3
○ Colour intensity	1
○ Layering	5
○ Point strength	4
○ Available individually, and in blisters, tins and tubs	

*Lightfast, colours remain the same for 100 years under museum conditions

ELEGANT COLOURED GRAPHITE. WATER-SOLUBLE

Used dry, Graphitint provides just a hint of colour but adding water transforms the tint into rich vibrant shades. Available in 24 tints, ranging from soft greys, blues and greens to glowing russets, plums and browns. Derwent Graphitint is ideal for landscapes, animal studies and portraits.

JAKE SPICER



Graphitint's muted colours make it perfect for my drawings, from autumnal landscapes to portraits, in a palette of warm and cool tones. With a smoother, waxier feel than a conventional graphite pencil and a dash of subtle colour, Derwent Graphitint are my go-to sketching pencil, with a water brush kept on hand to help dissolve the Graphitint into washes.



0700801



6
COLOURS

0700802



12
COLOURS

0700803



24
COLOURS

Also available:
0700804 Graphitint 72 Tub

						BW
	0700777	01 Port	●	●	●	V 6/7
	0700778	02 Juniper			●	V 6/7
	0700779	03 Aubergine		●	●	V 6
	0700780	04 Dark Indigo	●	●	●	V 7
	0700781	05 Shadow			●	V 7
	0700782	06 Steel Blue			●	V 8
	0700783	07 Ocean Blue			●	V 8
	0700784	08 Slate Green	●	●	●	V 8
	0700785	09 Green Grey			●	V 8
	0700786	10 Meadow			●	V 7
	0700787	11 Ivy	●	●	●	V 7
	0700788	12 Sage			●	V 7

						BW
	0700789	13 Chestnut		●	●	V 6/7
	0700790	14 Russet			●	V 6/7
	0700791	15 Cool Brown	●	●	●	V 7
	0700792	16 Cocoa		●	●	V 6
	0700793	17 Autumn Brown			●	V 7
	0700794	18 Storm		●	●	V 6
	0700795	19 Warm Grey			●	V 8
	0700796	20 Midnight Black		●	●	V 8
	0700797	21 Mountain Grey		●	●	V 8
	0700798	22 Cloud Grey		●	●	V 8
	0700799	23 Cool Grey		●	●	V 7/8
	0700800	24 White			●	V 8

● Blister of 6 ● Tin of 12 ● Tin of 24

BW - Derwent Lightfast ratings are graded using the Blue Wool Scale, graded 0-8. 8 is the highest rating and values of 6 or more are considered to be lightfast.
V - Vegan friendly





RANGE FEATURES

○ Texture	Smooth
○ Wax-based (contains graphite)	○
○ Water-soluble	●
○ Core size	4mm
○ No. degrees in range	3
○ Suitable for fine detail	○
○ Lightfast*	100%
○ Blendable	5
○ Erasable	5
○ Layering	5
○ Point strength	5
○ Available individually, and in blisters, tins and tubs	

*Lightfast, colours remain the same for 100 years under museum conditions

WATERSOLUBLE SKETCHING PENCILS

Delicate graphite washes, easy to blend and layer.

DELICATE GRAPHITE WASHES, EASY TO BLEND AND LAYER

Nothing beats graphite for drama and impact. But add a little water to any one of our water-soluble graphite ranges and an exciting new world of line and wash sketching opens up.

						BW
34341	Water-soluble Sketching HB	●	●	V		8
34342	Water-soluble Sketching 4B	●	●	V		8
34343	Water-soluble Sketching 8B	●	●	V		8

- Tin of 6 (contains 2 x HB, 2 x 4B, 2 x 8B and free sharpener)
- Tub of 72 (24 of each wash strength)

BW - Derwent Lightfast ratings are graded using the Blue Wool Scale, graded 0-8. 8 is the highest rating and values of 6 or more are considered to be lightfast.
V - Vegan friendly

Also available:
34344 Water-soluble Sketching 72 Tub

0700665



MIXED MEDIA

3 DEGREES

0700837



6 DEGREES

WATER-SOLUBLE SKETCHING STICK, QUICK COVERAGE AND MULTIPLE TONES

Amazing! No wood casing just pure water-soluble graphite in a stick! There are so many things you can do with Derwent Water-soluble Graphitone; you can use it like a pencil but the real fun begins when you peel off the wrapper! Use the stick whole or break it into chunks to create broad sweeps of tone really quickly, then just add water and watch the graphite dissolve into softness! You can choose from 4 wash strengths; from light to a very dark wash.

RANGE FEATURES

○ Texture	Smooth
○ Wax-based (contains graphite)	○
○ Water-soluble	●
○ Core size	7mm
○ Round stick of pure colour	○
○ 100% useable material (no wooden casing)	○
○ No. degrees in range	4
○ Suitable for fine detail	○
○ Lightfast*	100%
○ Blendable	3
○ Erasable	4
○ Layering	5
○ Point strength	4
○ Available individually and in blisters	

*Lightfast, colours remain the same for 100 years under museum conditions

34304



4 DEGREES

0700662



6 DEGREES

MIXED MEDIA

					BW
34301	Water-soluble Graphitone 2B	●	V		8
34302	Water-soluble Graphitone 4B	●	V		8
0700449	Water-soluble Graphitone 6B	●	V		8
34303	Water-soluble Graphitone 8B	●	V		8

● Blister of 4

BW - Derwent Lightfast ratings are graded using the Blue Wool Scale, graded 0-8. 8 is the highest rating and values of 6 or more are considered to be lightfast.
V - Vegan friendly



DERWENT

DRAWN TO PERFECTION

BLOCKS

BLOCKS



RANGE FEATURES

○ Texture	Soft
○ Water-soluble	○
○ Permanent once dry	○
○ Core size	8mm
○ No. colours in range	72
○ Suitable for use on fabric	○
○ Lightfast*	88%
○ Blendable	3
○ Colour intensity	5
○ Layering	4
○ Strength	3
○ Available individually and in tins and wooden boxes	

INKTENSE BLOCKS
Vibrant and versatile colour, permanent when dry

VIBRANT AND VERSATILE COLOUR, PERMANENT WHEN DRY

Derwent Inktense blocks are highly versatile water-soluble blocks which create vivid ink-like colour when combined with water. Highly pigmented dry colour transforms into a pure, translucent ink-like wash which is permanent once dry. Due to its permanence, Inktense can be worked over without affecting previous layers of vivid colour. Suitable for use on paper and fabrics for a wide range of fine art and craft projects. Inktense blocks are available in a range of 72 colours and are ideal for creating larger areas of colour and expressive marks.

ROBERT DUTTON



If you want to put some colour into your creativity, there is no better way than to start with Derwent Inktense blocks. The portable, easy to use, extensive colour range of Inktense, that creates such glorious intense colours in your paintings and drawings, is second to none. This exciting media has changed the way I work in so many positive ways and I'm sure Inktense will do the same for you too.

2300442



12 COLOURS

2300443



24 COLOURS

2301979



36 COLOURS

2301980



72 COLOURS

							BW
2300418	0100 Sherbet Lemon		●	●	●	●	8
2300419	0200 Sun Yellow	●	●	●	●	●	8
2302037	0210 Cadmium Yellow				●	●	7
2302038	0220 Sicilian Yellow				●	●	8
2302039	0230 Golden Yellow				●	●	7
2302040	0240 Sienna Gold			●	●	●	6
2302041	0250 Cadmium Orange				●	●	7
2302042	0260 Burnt Orange				●	●	6
2300420	0300 Tangerine	●	●	●	●	●	7
2302043	0310 Mid Vermilion				●	●	7
2302044	0320 Scarlet Pink				●	●	7
2300421	0400 Poppy Red	●	●	●	●	●	7
2302045	0410 Hot Red				●	●	7
2300422	0500 Chilli Red		●	●	●	●	7
2302046	0510 Cherry			●	●	●	6
2302047	0520 Carmine Pink				●	●	7
2302048	0530 Crimson				●	●	5/6
2300423	0600 Shiraz		●	●	●	●	4/5
2302049	0610 Red Violet			●	●	●	6
2300424	0700 Fuchsia	●	●	●	●	●	7
2302050	0710 Deep Rose				●	●	7
2302051	0720 Thistle				●	●	6/7
2302052	0730 Dusky Purple				●	●	7
2302053	0740 Mauve			●	●	●	7
2302054	0750 Dark Purple				●	●	7
2302055	0760 Deep Violet				●	●	6
2300425	0800 Violet		●	●	●	●	7
2302056	0810 Lagoon				●	●	7
2302057	0820 Peacock Blue			●	●	●	7
2302058	0830 Navy Blue				●	●	7
2302059	0840 Iron Blue				●	●	8
2302060	0850 Deep Blue				●	●	7/8
2300426	0900 Iris Blue		●	●	●	●	7
2300427	1000 Bright Blue		●	●	●	●	7
2300428	1100 Deep Indigo	●	●	●	●	●	7
2300429	1200 Sea Blue	●	●	●	●	●	7

							BW
2302061	1210 Dark Aquamarine				●	●	8
2302062	1215 Turquoise				●	●	8
2302063	1230 Mallard Green				●	●	8
2302064	1220 Green Aquamarine				●	●	8
2300430	1300 Teal Green	●	●	●	●	●	8
2302065	1310 Iron Green			●	●	●	8
2300431	1320 Ionian Green		●	●	●	●	8
2302066	1330 Vivid Green				●	●	7
2300432	1400 Apple Green	●	●	●	●	●	8
2300433	1500 Field Green		●	●	●	●	7
2302067	1510 Beech Green				●	●	7
2302068	1520 Hooker's Green				●	●	8
2302069	1530 Felt Green				●	●	7
2302070	1540 Light Olive				●	●	7
2302071	1550 Spring Green				●	●	7
2302072	1560 Fern				●	●	8
2300434	1600 Leaf Green	●	●	●	●	●	8
2300435	1700 Mustard		●	●	●	●	6
2302073	1710 Amber				●	●	8
2302074	1720 Tan				●	●	7
2302075	1730 Oak				●	●	8
2302076	1740 Saddle Brown				●	●	8
2300436	1800 Baked Earth	●	●	●	●	●	8
2300437	1900 Willow		●	●	●	●	8
2302077	1910 Red Oxide				●	●	8
2302078	1920 Madder Brown				●	●	8
2302079	1930 Dark Chocolate				●	●	7
2300438	2000 Bark	●	●	●	●	●	8
2302080	2010 Sepia Ink				●	●	8
2302081	2020 Indian Ink				●	●	8
2302082	2030 Chinese Ink				●	●	8
2300439	2100 Charcoal Grey		●	●	●	●	7
2302083	2110 Payne's Grey				●	●	8
2302084	2120 Neutral Grey				●	●	8
2300440	2200 Ink Black	●	●	●	●	●	8
2300441	2300 Antique White		●	●	●	●	8

● Tin of 12 ● Tin of 24 ● Tin of 36 ● Tin of 72

BW - Derwent Lightfast ratings are graded using the Blue Wool Scale, graded 0-8. 8 is the highest rating and values of 6 or more are considered to be lightfast.

V - Vegan friendly



RANGE FEATURES

XL BLOCKS GRAPHITE
Quick coverage for creative sketching.

Texture	Chalky
Powder-based	○
Water-soluble	●
Diameter	20mm
Length	60mm
No. degrees in range	6
Lightfast*	100%
Blendable	5
Erasable	4
Colour intensity	2
Layering	5
Strength	3
Available individually and in tins	

*Lightfast, colours remain the same for 100 years under museum conditions

QUICK COVERAGE FOR CREATIVE SKETCHING

Everything about Derwent XL Graphite is big; big blocks and even bigger possibilities. You will find you can create a wide variety of textures and effects with these generous graphite blocks; subtle blending, fine lines and deep tonal work are all possible. The graphite is watersoluble too so that means even more possibilities! We have developed 6 dense shades from Olive Green to Burnt & Raw Umber which work really well for bold landscapes.

IAN HODGSON



Incredibly versatile, XL Graphite blocks are capable of creating a wide range of textures and effects from subtle blending and sensitive work through expressive mark making to the densest of tones and shading. I often work with an eraser; rubbing, manipulating and working back into the graphite, and these blocks respond beautifully to this technique. An absolute pleasure to use, the chunky graphite blocks have opened up exciting new possibilities for my art practice, I can't get enough of them!

2302010

					BW
	2302017	01 Olive Green	●	V	8
	2302018	02 Dark Prussian	●	V	8
	2302019	03 Raw Umber	●	V	8
	2302020	04 Burnt Umber	●	V	8
	2302021	05 Soft	●	V	8
	2302022	06 Very Soft	●	V	8

● Tin of 6

BW - Derwent Lightfast ratings are graded using the Blue Wool Scale, graded 0-8. 8 is the highest rating and values of 6 or more are considered to be lightfast.
V - Vegan friendly



6 COLOURS

RANGE FEATURES

NATURAL GRAPHITE
Natural graphite in block form.

Texture	Chalky
Graphite based (contains wax)	○
Naturally water-soluble	●
Diameter:	8mm
Length	75mm
Lightfast*	100%
Blendable	4
Erasable	4
Layering	4
Available individually	

*Lightfast, colours remain the same for 100 years under museum conditions

NATURAL GRAPHITE IN BLOCK FORM

Natural graphite was first discovered in the Lake District and now it's your chance to discover Derwent Natural Graphite blocks! They're brilliant for creating big dramatic pictures whether you use them flat or on their edge. Blending them couldn't be easier, use either your fingers or a paper stump if you prefer. You've got three grades to choose from: soft, medium or hard and, if that wasn't enough, they're naturally water-soluble too!

				BW
	35986	Natural Graphite Soft	V	8
	35987	Natural Graphite Medium	V	8
	35988	Natural Graphite Hard	V	8

BW - Derwent Lightfast ratings are graded using the Blue Wool Scale, graded 0-8. 8 is the highest rating and values of 6 or more are considered to be lightfast.
V - Vegan friendly





RANGE FEATURES

XL BLOCKS CHARCOAL
Quick coverage for creative sketching.

○ Texture	Chalky
○ Powder-based	○
○ Water-soluble	○
○ Diameter	20mm
○ Length	60mm
○ No. degrees in range	6
○ Lightfast*	100%
○ Blendable	5
○ Erasable	4
○ Colour intensity	2
○ Layering	5
○ Point strength	4
○ Available individually and in tins	

*Lightfast, colours remain the same for 100 years under museum conditions

QUICK COVERAGE FOR CREATIVE SKETCHING

Charcoal just got bigger and more beautiful. These blocks have all the qualities of charcoal that you love, in a chunky XL form. Combine that with rich natural colours and what have you got? An artist's dream! The blocks come in 6 muted shades from Sanguine and Violet to Sepia and Ochre. Naturally water-soluble you can use them on a damp surface and release lots of colour really quickly. Build up layers of different colours as you go.

DAVID WINNING



These chunky XL blocks are an artists' dream; delivering enormous swatches of rich colour. On a damp surface they release a creamy strip of live pigment, which when dry can be re-worked with layers of contrasting colour and marks. Blend colour with a stump or by hand, or removing sections with an eraser, water, wire wool or sandpaper. Working with them is a truly rewarding creative experience.

RANGE FEATURES

COMPRESSED CHARCOAL
Strong and chunky.

○ Texture	Chalky
○ Powder-based	○
○ Water-soluble	○
○ Diameter	8mm
○ Length	75mm
○ No. degrees in range	3
○ Lightfast*	100%
○ Blendable	5
○ Erasable	4
○ Layering	4

*Lightfast, colours remain the same for 100 years under museum conditions

STRONG AND CHUNKY

Derwent Compressed Charcoal is a chunky block of pure charcoal. It's great for using with our other charcoal products or try it on its own for wide sweeping strokes using its side, or the end for finer lines.

				BW	
35997	Compressed Charcoal Light	●	V	8	
35998	Compressed Charcoal Med	●	V	8	
35999	Compressed Charcoal Dark	●	V	8	

● Blister of 6

BW - Derwent Lightfast ratings are graded using the Blue Wool Scale, graded 0-8. 8 is the highest rating and values of 6 or more are considered to be lightfast. V - Vegan friendly

				BW	
2302011	01 Ochre	●	V	8	
2302012	02 Sanguine	●	V	7	
2302013	03 Violet	●	V	8	
2302014	04 Sepia	●	V	8	
2302015	05 Black	●	V	8	
2302016	06 White	●	V	8	

● Tin of 6

BW - Derwent Lightfast ratings are graded using the Blue Wool Scale, graded 0-8. 8 is the highest rating and values of 6 or more are considered to be lightfast. V - Vegan friendly





DERWENT
DRAWN TO PERFECTION
PENS

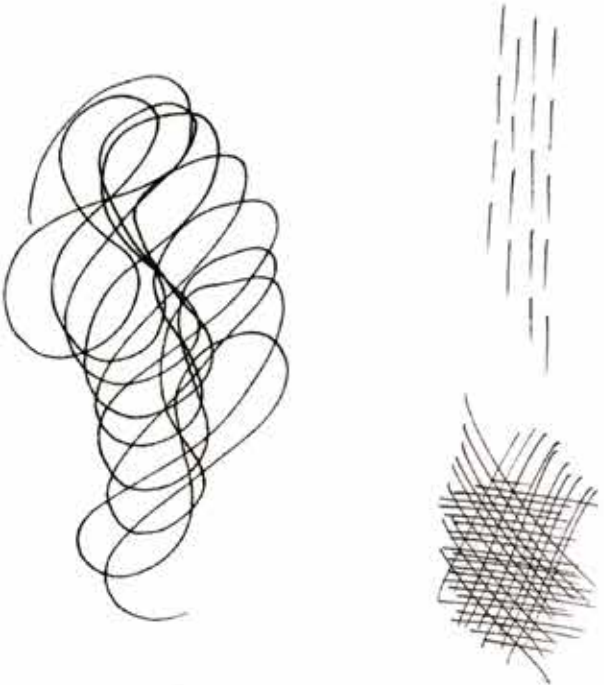

Using the new permanent black line makers enables me as an urban sketcher to create a detailed visual response to the world around me. Their superfine tips provide a greater level of precision, and their free flowing quality helps develop speed and accuracy; which can be essential for location drawing.

RANGE FEATURES

LINE MAKER	
Superfine, free-flowing permanent liners.	
Water-based pigment ink	○
Solvent free	○
Permanent once dry	○
Nib size	0.05/0.1/0.2/ 0.3/0.5/0.8mm
Barrel shape	Round
No. colours/degrees available	9
Suitable for fine detail	○
Lightfast*	78%
Colour intensity	5
Layering	4
Point strength	3
Available individually and in cartons	

*Lightfast, colours remain the same for 100 years under museum conditions

SUPERFINE, FREE-FLOWING PERMANENT LINERS

Derwent Line Makers are superfine, free-flowing fine liners with a consistent line, ideal for both drawing and writing. Line Makers contain permanent, fast drying pigment ink, with intense colour which dries quickly and will not move once dry. Create beautiful opaque, solid lines with speed, ideal for artwork and hand lettering either in the studio or when on location. Comfortable to hold with a high quality Japanese nib that is highly durable, ideal for a variety of mixed media techniques. All colours are highly lightfast, colours will not fade for a long period of time. Available in Black, Sepia and Graphite plus 6 new colours. Nib sizes range from a super-fine 0.05 to a bold 0.8 (black only).



2305560

2305561

2305562

2305559

2305576



				BW
2305563	Black 0.05		●	8
2305564	Black 0.1	●	●	8
2305565	Black 0.2		●	8
2305566	Black 0.3	●	●	8
2305567	Black 0.5	●	●	8
2305568	Black 0.8		●	8
2305569	Sepia 0.1	●		8
2305570	Sepia 0.3	●		8
2305571	Sepia 0.5	●		4
2305572	Graphite 0.1	●		4
2305573	Graphite 0.3	●		4
2305574	Graphite 0.5	●		4
2305577	Yellow 0.3		●	8
2305578	Red 0.3		●	5
2305579	Pink 0.3		●	8
2305580	Purple 0.3		●	8
2305581	Blue 0.3		●	8
2305582	Green 0.3		●	8

● Pack of 3 ● Pack of 6

BW - Derwent Lightfast ratings are graded using the Blue Wool Scale, graded 0-8. 8 is the highest rating and values of 6 or more are considered to be lightfast.

V - Vegan friendly

RANGE FEATURES

PAINT PEN	
Water-based pigment ink	○
Solvent free	○
Permanent once dry	○
Water-soluble	○
Nib size	0.5mm
Barrel shape	Round
No. colours/degrees available	20
Suitable for fine detail, painting techniques and use on fabric	○
Lightfast*	85%
Colour intensity	5
Layering	5
Point strength	3
○ Available individually and in cartons	

*Lightfast, colours remain the same for 100 years under museum conditions

PERMANENT, HIGHLY LIGHTFAST, OPAQUE PAINT PENS

Derwent Paint Pens are a creative drawing and painting tool which are permanent and highly lightfast. The high quality 0.5 Japanese nibs are very durable and allow for a variety of unique paint effects from fine lines to large layers and exciting splatters. Choose from a wide selection of vivid, opaque colours which can be layered and blended, dilute with water and brush whilst wet to create transparent washes that inspire. Once dry, colours are permanent and fixed.

Also available:
2302235 Paint Pen Medium Waterbrush

CARNE GRIFFITHS



I have been using the Derwent Paint Pens for years now, for me they are a perfect accompaniment to my work, being fluid and free when I need them to be - I can use them to create watercolour effects - bold splashes of colour and subtle blends. Then when I need control and detail the fine nib provides control for adding fine details like floral shapes and crosshatching. Having a pen that is water soluble when wet and then permanent when dry is perfect for creating layered work with expressive marks and then increasing detail as I work. The pens work brilliantly alongside and over other media such as watercolour, acrylics and spray paints.

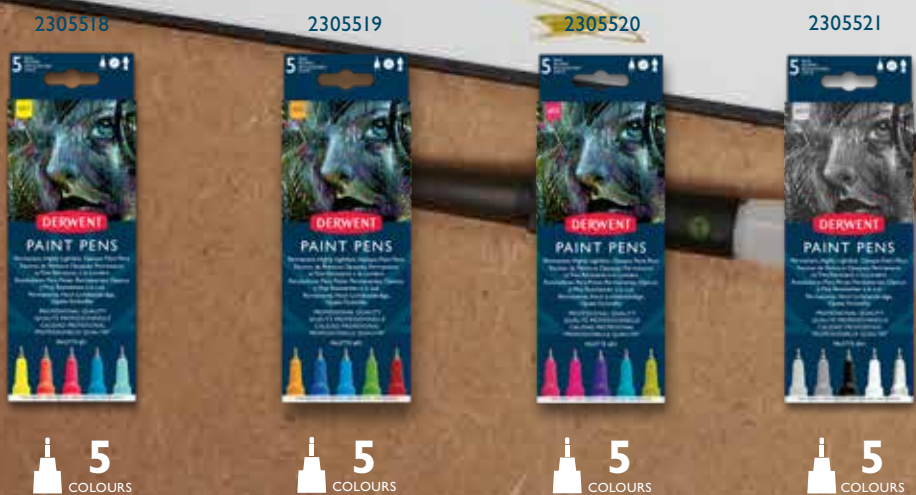

Color	Product #	Name	Lightfast (BW)
Yellow	2305522	Lemon Yellow	7
Orange	2305523	Middle Chrome	5
Red	2305524	Scarlet	7
Red-Orange	2305525	Primary Red	8
Pink	2305526	Cranberry	8
Magenta	2305527	Magenta	8
Purple	2305528	Violet	8
Blue	2305529	Dark Blue	8
Bright Blue	2305530	Bright Blue	8
Green	2305531	Sea Green	8
Blue	2305532	Ocean Blue	8
Mint Green	2305533	Mint Green	8
Light Green	2305534	Mid Green	7
Yellow-Green	2305535	Leaf Green	7
Red-Orange	2305536	Terracotta	7
Grey	2305537	Concrete	8
Black	2305538	Graphite	8
Black	2305539	Black	8
White	2305540	White	8
Grey	2305541	Silver	8

● Palette #01 ● Palette #02 ● Palette #03 ● Palette #04

BW - Derwent Lightfast ratings are graded using the Blue Wool Scale, graded 0-8. 8 is the highest rating and values of 6 or more are considered to be lightfast.

V - Vegan friendly

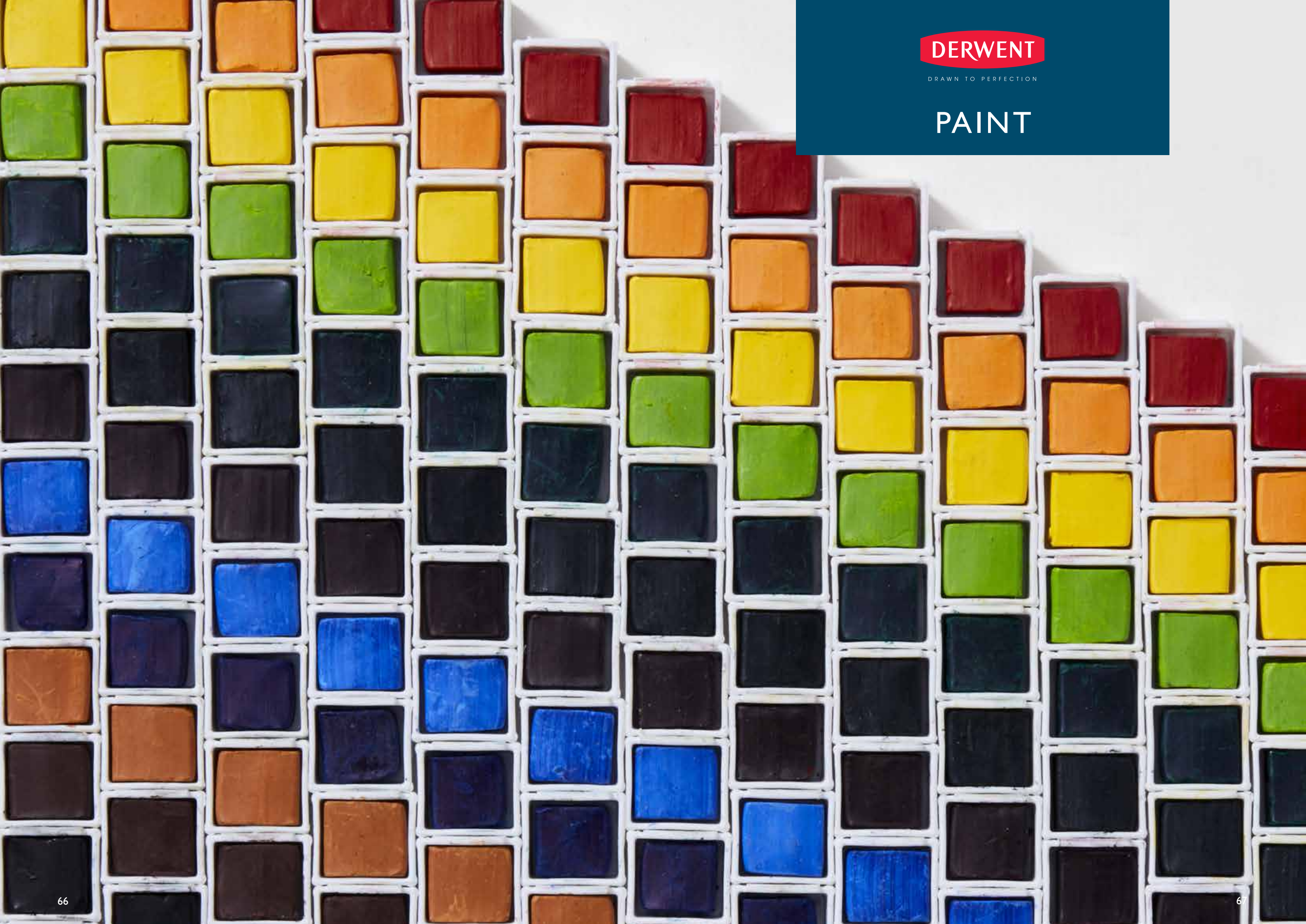

DERWENT

DRAWN TO PERFECTION

PAINT



WATERCOLOUR PADS

Developed for water-soluble pencils, this smooth paper is perfect for all water-soluble media including Derwent Inktense pencils and blocks and Derwent Watercolour pencils. Unlike other watercolour paper, the smooth surface provides an excellent base for detailed watercolours and dry pencil work. The range features stitched binding and 12 sheets of 300gsm (140lbs) acid free paper. Available in A2, A3, A4 and A5 sizes.

A2 Landscape 2301972	
A4 Portrait 2301970	A3 Landscape 2301971
A5 Portrait 2301969	



SKETCH PADS

Our popular heavyweight sketch pads are available in white paper and are perfect for pencil work and light washes. The slightly textured surface is ideal for holding pencil pigments, allowing effective layering of colours. The range features a wirebound spine and 30 sheets of 165gsm (110lbs) acid free paper. Available in A3, A4 and A5 sizes.

A4 Portrait 2300139	A3 Landscape 2300141
A5 Portrait 2300140	



BIG BOOKS

These wirebound sketchbooks have a bumper stack of 86 perforated sheets, ideal for sketching and drawing. Featuring 110gsm (75lbs) acid free paper and a hard wearing black vinyl cover, the range is available in A4 and A5 sizes.

A4 Portrait 2301607
A5 Portrait 2301608



BLACK PAPER

Suitable for dry or water-soluble mediums, this deep black paper is perfect for a variety of art and craft projects using Derwent Lightfast, Procolour, Metallics and Graphitint collections. An elastic strap and hard wearing matt black cover keep the book secure. The range features a wirebound spine and 40 sheets of 200gsm (135lbs) acid free paper. Available in A3 and A4 sizes.

A4 Portrait 2300379	A3 Landscape 2300381
-------------------------------	--------------------------------



SKETCH AND STORE BOOKS

Designed to accommodate extra paper and additional items, these wirebound sketchbooks have wider rings, an elastic strap to keep loose sheets in place, and an expanding pocket at the back. The range features 56 sheets of 165gsm (110lbs) acid free paper and a hard wearing black vinyl cover. Available in A3, A4 and A5 sizes.

A4 Portrait 2102178	A3 Landscape 2102174
A5 Portrait 2102179	



A wide variety of sharpening products; specifically designed with the artist in mind.



1. MANUAL TWIN HOLE SHARPENER

Sharpens both large and small diameter pencils* with shavings neatly caught in a transparent reservoir. Lockable cap prevents shavings spilling out. Available individually in hanging bags.

2301930

2. CRAFT KNIFE

An ideal tool for both sharpening and scraping colour from various media onto a piece of work for interesting effects. Features 'soft feel' handle. Replacement blades available. Available individually in blister packs.

2301932 Craft Knife

2301936 Replacement Blades

3. DUAL 2-IN-1 SHARPENER ERASER

Sharpens pencils up to 8mm in diameter with 360° rotating barrel for collecting and disposing of shavings. Offers clean and smudge free erasing. Available in CTU trade packs of 10.

2302376



4. METAL PENCIL SHARPENER

Designed to fit all Derwent ranges. Sharpens pencils to a fine point. Available in CTU trade packs of 20.

0700233

5. PASTEL PENCIL SHARPENER

Specifically designed for use with the more fragile Derwent Pastel pencil and Derwent Charcoal pencil mediums. Also suitable for sharpening other large diameter pencils such as Derwent Drawing and Artists pencils. Available in CTU trade packs of 14.

0700234

6. BATTERY OPERATED TWIN HOLE SHARPENER

Compact battery operated sharpener suitable for both large and small diameter pencils*. Durable blades can withstand hours of sharpening and shavings are neatly caught in a transparent reservoir. Includes broken tip remover. Requires 4 x AA batteries (not supplied). Available individually, box packed.

2302332 Battery Operated Twin Hole Sharpener

2302353 Replacement Sharpeners

7. SUPER POINT MANUAL HELICAL SHARPENERS

Designed to sharpen pencils to the optimum super fine point. Extendable front plate features self feeding mechanism which stops when a superb point has been achieved and no further sharpening is required. For pencils up to 8mm in diameter. Includes sliding tray reservoir and desk clamp. Available individually, box packed.

2302001 Super Point Manual Helical Sharpener

2302000 Super Point Mini Manual Helical Sharpener



* Large (9-12mm)/Small (6-8mm)

I. BATTERY OPERATED ERASER

Developed for detailed work, this battery operated eraser offers speed and precision for correcting small areas of work. Comfortable for both left and right handed use. Includes 8 long-lasting eraser tips. Requires 1 x AAA batteries (not supplied). Available individually in blister pack.

2301931 Battery Operated Eraser
2300023 Replacement Tips



2. PLASTIC ERASER

Cleanly removes areas of graphite or unwanted marks. Well defined corners and edges give total control and can be re-cut with a sharp knife. Available individually, loose packed.

0700232

3. SHAPED ERASERS

Easy to hold and control, these shaped erasers can be used to draw shapes in graphite, and to create light and tone. They provide an alternative grip to traditional rectangular shaped erasers. Available in blister pack of two.

2301964

4. KNEADABLE ERASER

Soft and pliable erasers; mouldable to a desired shape or point. For use in large and small areas to add highlights, stippling and ghosting. Features wax paper wrap to maintain freshness. Available individually, loose packed or in blister pack.

0700231 Kneadable Eraser

2301976 Kneadable Eraser Blister



5. ERASER PENCIL AND BRUSH

Designed to provide enhanced control, minor errors can be erased or corrected. Useful for cleaning up white paper surrounding an image. Gently sweep away debris with the brush tip. Sharpen using the Derwent Craft Knife. Available in blister pack of two.

2301933

6. DUAL ERASER PACK

Effective erasing for all types of pencil work. The Art Eraser is compatible across graphite and colour pencil. The Soft Eraser provides a gentler line for less damage to paper. PVC and latex free; non-toxic. Available in blister pack of 2.

2301963





TECHNIQUE BRUSHES

An assortment of brushes for different painting techniques. Each brush is designed to produce different marks, allowing the artist greater creative possibilities. Available in blister pack of six.

2302003

1. FOAM BRUSH

The Foam Brush is perfect for laying down a wash over a large area or background.

3. FAN BRUSH

When wet, the Fan Brush separates into fine points which can be used to create delicate marks such as hair and foliage.

2. SWORDLINER BRUSH

Ideal for petals and leaves the Swordliner Brush is an exquisite brush for flowing marks; glide between fine lines and teardrop shapes.

4. COMB BRUSH

Perfect for grasses and fur the Comb Brush is a close relative of the fan brush and can be used anywhere you want fine separated lines. It is also used for adding texture and hatching.

5. FLAT BRUSH

The Flat Brush has great colour carrying capacity for laying down colour quickly with ease and can be used for both broader strokes and fine lines.

6. RIGGER BRUSH

The Rigger Brush is the perfect tool for adding detail. Producing fine lines with a consistent width it is ideal for delicate lines and intricate work.

WATERBRUSHES

Portable, leak proof and easy to clean. Each features a non-drip valve for easy to control water flow. Fine, Medium and Chisel tip heads are easily distinguished by number so you can grab the one you need. Available individually and in hanging bags of three.

While compatible with all water-soluble media, these waterbrushes are particularly popular with Derwent Inktense blocks. By scratching pigments into the empty chamber and adding water, a myriad of ink-like colours and tones can be created.

- 2300123 Small Waterbrush (1)
- 2301760 Medium Waterbrush (2)
- 2301974 Chisel Tip Waterbrush (3)
- 2301975 Waterbrush 3 Pack



BLENDER AND BURNISHER

BLENDER

A soft colourless pencil that allows you to blend two or more colours together to create a new colour. At the same time it physically mixes and smoothes the pigments so individual strokes and hard edges are softened. Available individually, in blister pack of four, and tub packs.

BURNISHER

A hard colourless pencil which when used over layers of pigment provides a rich polished finish. Available individually, in blister pack of four, and tub packs.

- 2301756 Blender Pencil
- 2301757 Burnisher Pencil
- 2301774 Blender & Burnisher Blister 4 Pack
- 2301758 Blender & Burnisher 72 Tub



BLENDER PEN

Designed for use with wax based pencils, the blender pen allows the artist to blend away pencil lines, creating smooth and even colour. Effective with both colour and graphite pencils. Available in twin pack of two nib sizes; 2mm and 4mm.

2302177



PAPER STUMPS

Made from compressed rice paper and with a point at each end, paper stumps make blending charcoal and pastel much easier. Once the stump gets dirty and the point wears down they can be easily cleaned and re-pointed using a sandpaper block. Available individually in medium size and in blister packs of 3; small, medium and large (ranging from 5.5mm diameter to 10.5mm).

- 0700230 Paper Stump Medium
- 2300561 Paper Stumps Blister 3 Pack



SCALE DIVIDER

Ingenious drawing tool designed to transfer measurements from life to paper; ensuring accurate proportions every time. Scale pictures in ratios from 4:1 to 1:4. Folds neatly away and will slip easily into a backpack for easy travel. Available individually in blister pack.

2300580



PENCIL EXTENDER

Designed to prolong the life of your pencil. Available in blister pack of two sizes; small for standard size pencil barrels, and large for pencils such as Derwent Inktense and Artists.

2300124



SPRITZER

Adds a new creative dimension to water-based projects. Spray water directly over water-soluble drawings to create interesting textures, colour runs and dribble effects. Dissolve colour pigment and fill the Spritzer to spray straight onto an image. Available individually in blister pack.

2300592





1. POCKET WRAP

Petite, compact and durable canvas wrap. Holds 12 pencils. Available individually in hanging bag. 2300219

2. PENCIL TIN

Smart, robust, double layer pencil tin. Features removable inner tray. Holds at least 18 pencils. Available individually in hanging bag. 2300582

3. ARTPACK

Durable canvas case featuring mesh and transparent zipped pockets. Hold 20 pencils. Available individually in hanging bag. 2300575

4. PENCIL WRAP

The original Derwent Pencil Wrap, made from durable canvas material. Medium storage option featuring individual compartments to hold at least 27 pencils and accessories. Rolls up compactly. Available individually in hanging bag. 0700434

5. A4 CARRY-ALL FOLIO

The ultimate storage solution; multipurpose A4 folio which holds up to 68 pencils, accessories and an A4 pad. Also available in black canvas.

Ideal for travel with secure zip around closure. Contains a 3-ring binder with internal A4 Carry-All sleeve and internal mesh zip compartment for artists accessories. Available individually in hanging bag.

2302619 Natural canvas
2302646 Black canvas



6. CARRY-ALL BAG

Large, durable canvas storage solution for 132 pencils. Includes accessory and A5 sketch book pocket, three removable pencil leaves and adjustable shoulder strap. Available individually in hanging bag. 2300671

CARRY-ALL BAG LEAVES

Additional pencil leaves for the Carry-All Bag which can hold up to five leaves. Each leaf holds 44 pencils. Can also be used in a ring binder. Available in hanging bag pack of two. 2302141

DERWENT

DRAWN TO PERFECTION

GIFTING



Explore a variety of media in one tin.



PASTEL COLLECTION

Smudge and blend an assortment of 8 chunky Pastel blocks and 14 Pastel pencils. Includes kneadable eraser and essential Pastel pencil sharpener.

0700301 Pastel Collection 24 Tin



COLOUR COLLECTION

A mix of old favourites and newer innovation, the Colour Collection features 2 Metallic, 8 Studio and 10 Coloursoft pencils. Includes pencil sharpener, plastic eraser and Blender and Burnisher pencils.

0700212 Colour Collection 24 Tin



SKETCHING COLLECTION

Available in two sizes, the Sketching Collection includes an impressive assortment of mixed sketching media and accessories.

12: 3 Graphite blocks, 3 Charcoal blocks, 3 Water-soluble Sketching pencils, 1 Drawing pencil, 1 Charcoal pencil, 1 Tinted Charcoal pencil

24: 4 Graphite blocks, 3 Charcoal blocks, 3 Water-soluble Sketching pencils, 2 Graphic pencils, 2 Drawing pencils, 3 Charcoal pencils, 3 Tinted Charcoal pencils, pencil sharpener, kneadable eraser

34305 Sketching Collection 12 Tin

34306 Sketching Collection 24 Tin



WATERCOLOUR COLLECTION

A versatile mix of water-soluble media, available in two sizes.

12: 6 Inktness blocks, 3 Inktness pencils, 3 Watercolour pencils
24: 6 Inktness blocks, 8 Inktness pencils, 8 Watercolour pencils, 1 Water-soluble Sketching pencil, paint brush

0700303 Watercolour Collection 12 Tin

0700304 Watercolour Collection 24 Tin



Two tiered wooden boxes containing a special selection of up to 120 professional quality Derwent fine art pencils. Lifetime gifts for any artist.



48 WOODEN BOX

- 0700643 Artists 48 Wooden Box
- 2300151 Inktnse Pencils 48 Wooden Box
- 0700758 Watercolour 48 Wooden Box
- 0700822 Studio 48 Wooden Box
- 2301660 Coloursoft 48 Wooden Box
- 0700644 Pastel Pencil 48 Wooden Box
- 0700759 Sketching 48 Wooden Box
- 2302523 Procolour 48 Wooden Box



72 & 120 WOODEN BOX

- 2301844 Inktnse Pencils 72 Wooden Box
 - 32891 Watercolour 72 Wooden Box
 - 32199 Studio 72 Wooden Box
 - 0701031 Coloursoft 72 Wooden Box
 - 2300343 Pastel Pencil 72 Wooden Box
 - 2301902 Sketching 72 Wooden Box
 - 2302524 Procolour 72 Wooden Box
-
- 32098 Artists 120 Wooden Box (pictured left)
 - 2302732 Limited Edition 120 Water-soluble Pencil Collection
 - 2302731 Limited Edition 120 Coloured Pencil Collection



PENCIL WRAP SETS

The most convenient way to carry pencils around when out and about. Made from tough canvas with faux-leather trim and a secure closure, it has compartments to hold and protect at least 27 standard-size pencils together with other accessories.

- 2302163 Inkense Wrap Set (24)
- 2302583 Procolour Wrap Set (24)
- 2301999 Coloursoft Wrap Set (24)



BULLET & SKETCHING JOURNAL SETS

BULLET JOURNAL SET

Designed to be as individual as you are, a bullet journal is a customisable system to keep you on top of your yearly goals, weekly plans and daily to-dos.

SKETCHING JOURNAL SET

The perfect Sketcher's companion, this journal has been designed with practicality in mind. At a handy A5 size you're ready to capture the world around you at a moment's notice. Complete with a pen wrap and our lightfast water-based Graphik Line Makers, these sets have everything for art on the move.

- 2302733 Bullet Journal Set
- 2302734 Sketching Journal Set



INKTENSE WASH SET

Perfect for gifting, this stylish and practical double layered tin contains everything needed to inspire a wide range of fine art and craft projects using Derwent Inkense pencils and accessories.

2302584



PROCOLOUR WALLET

Perfect for artists on the move, the Derwent Procolour Wallet contains everything you need to get creative outdoors. Accompanied by an A5 Sketching Pad, two Graphic pencils and a bundle of handy accessories.

2302582



HAND LETTERING SET

Bring vibrant ink-like colour to your lettering work with the unique formulation of Inkense. Permanent once dry, these water-soluble pencils create bright translucent washes, onto which dry or wet pigment, graphic pencil, and pen can be applied with no colour lift or transfer. Blend, mix, layer and explore a variety of lettering media with this set.

2305500



DERWENT

DRAWN TO PERFECTION

ACADEMY

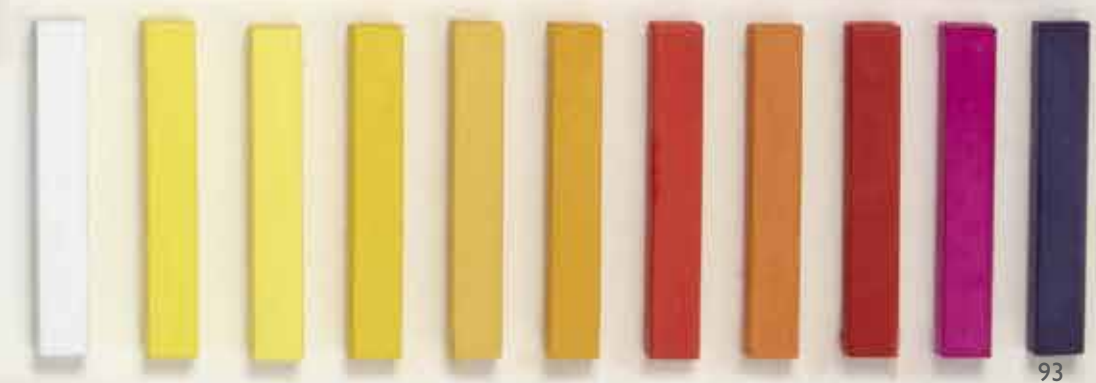

Derwent Academy has been created for aspiring artists wishing to develop and improve their skills. Judith Selcuk takes us through her key recommendations from the Academy range, and how to get the most from the variety of media on offer. An award winning professional freelance illustrator and artist, Judith trained at Falmouth School of Arts in Graphic Design and has since gone on to pursue a career in art and design. As an artist and demonstrator she can be seen all over the country at art fairs, major art stores and events and trade shows. Judith has published several books internationally on her art techniques and holds regular lessons and workshops in the UK, primarily from her studio in Worcestershire.

ACADEMY SKETCHING PENCILS

Sketching pencils come in a range of hard to soft graphite. The higher the H numbers the harder the graphite, and the lighter tone it will create. B pencils are softer and make darker, richer tones. Use a variety of tones in your drawing to create depth and dimension. Blend soft areas by scribbling a B grade pencil on scrap paper and rub with cotton wool. Then transfer to your drawing for soft areas of shading such as shadows and clouds. Remove highlights with an eraser and blend smaller defined areas with a paper stump. Avoid smudging with your hand by placing a spare sheet of paper underneath.

ACADEMY WATERCOLOUR PENCILS

Clean and portable, watercolour pencils make the perfect tool for college, home and outdoor use without the need for water pots or mess. Washes are easily achieved by lightly shading the paper and using a water brush over the top to turn the pencil into watercolour. For layers of colour allow each previous layer to dry before adding the next. Interesting effects can be achieved by drawing into a wet paper surface or previous wash with a dry pencil, as well as wetting the pencil tip with water and 'painting' with the pigment in the core of the pencil. Watercolour pencils prefer a cartridge paper or a hot press watercolour paper with just enough texture to grip the pigment without becoming too textured to allow smooth shading and details.

ACADEMY METALLIC MARKERS

Perfect for lettering and illustration, these highly metallic markers work equally well on black paper as well as white, preferring a smoother surface to create clean lines and blends. Allow sections to dry to prevent smudging and colour transfer. This also enables layering with their opaque quality ink. Each metallic colour is very different and the firm nib holds its shape well. Always replace the cap on the pen when not drawing with it, even for brief periods to prevent any ink drying on the nib. Store pens horizontally when not in use to prevent the nib drying out or the pigment settling at the bottom of the pen.

Artist commissions: Judith Selcuk

ACADEMY ACRYLIC PAINTS

Acrylic paints are incredibly versatile and can be used in thin washes or in thick impasto layers. Acrylics work best on canvas or acrylic paper with a texture. For best results use two different pots of water, one for washing your brushes and one for mixing colours and washes. You can control the amount of water you use by wiping any excess off on kitchen roll. That way colours and your thickness of paint will stay consistent. Try painting a wash of acrylic first to cover the white of the canvas then built up depth and texture once dry. You can use a variety of interesting objects to create marks and patterns such as pen or bottle tops.



ACADEMY OIL PASTELS

Create exciting marks and textures with oil pastels. Try layering oil pastels and scraping back off with a sharp craft knife or scalpel. You can then add more oil pastel and repeat countless times. Choose a paper with a light texture to grip the oil pastel as it will not adhere well to a smooth surface. Oil pastels are full of lovely bright pigments so do not erase. Avoid smudging by putting a piece of tracing paper under the hand you draw with. Store safely with a sheet of glassine paper on top.

ACADEMY SOFT PASTELS

Soft pastels are perfect for layering and building up depth and tone, and also for a variety of mark making techniques. To release maximum pigment scrape the harder exterior off and release the beautiful pigment within. Soft pastels work best on a textured paper to grip the pastel, and look fantastic on a coloured pastel paper! They can be erased to create detail and textures and used on their side for block shading areas quickly. Blend with paper stumps to avoid skin oils being transferred to your paper. Store horizontally if possible with a sheet of tracing or glassine paper over the top.



Academy pencils are ideal for colouring, drawing and illustration, are easy to use and retain the high standards expected from Derwent.

I. ACADEMY WATERCOLOUR PENCILS

RANGE FEATURES

- 24 water-soluble colours
- Made with natural wood barrels and quality water-soluble pigments
- Hexagonal barrel offers a secure grip
- Conveniently packaged in a tin storage case



ACADEMY WOODEN BOX

2300147

A great range of essentials to introduce you to the world of drawing. This stylish wooden box contains 30 pencils, including 12 Academy Colour Pencils, 12 Academy Watercolour Pencils and 6 Academy Sketching Pencils, a sharpener, an eraser, an A5 pad of paper, and a paintbrush.



2. ACADEMY COLOURING PENCILS

RANGE FEATURES

- 24 blendable colours
- Made with natural wood barrels and rich, creamy pigments
- Round barrels give freedom of movement to your drawing technique
- Conveniently packaged in a tin storage case

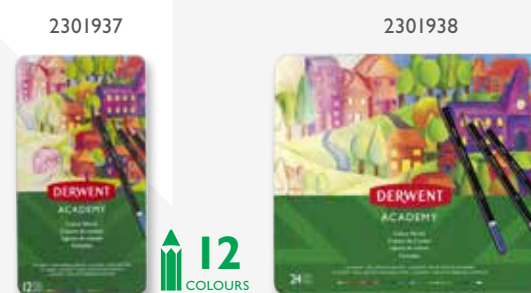

3. ACADEMY SKETCHING PENCILS

RANGE FEATURES

- 12 degrees from: 5H to 6B
- Hexagonal barrel offers a secure grip



DERWENT ACADEMY PASTELS

Available in creamy oil or as a soft chalky block, Derwent Academy Pastels are a great introduction to pastel media.



1.

1. ACADEMY OIL PASTELS

RANGE FEATURES

- 24 bright colours
- Creamy texture, dust free
- Soluble in turpentine which thins the pastels to give a stunning translucent effect



2301952



12 COLOURS

2301953



24 COLOURS



2.



4.



2. ACADEMY SOFT PASTELS

RANGE FEATURES

- 24 bright colours
- Easy to blend
- Great for techniques like layering and texturing



2302397



12 COLOURS

98216



24 COLOURS

ACADEMY ACRYLIC PAINTS

Derwent Academy acrylic paints are fast drying compared to oil paints. A formulation that retains tinting strength, colour vibrancy and consistency whether used alone or mixed with other painting mediums.

RANGE FEATURES

- 24, 12ml tubes of acrylic paint
- Made from rich pigments and a formulation that retains tinting strength, colour vibrancy and consistency whether used alone or mixed with other painting mediums
- Use straight from the tube or dilute with water or a painting medium to achieve lighter wash effects



2302401

98226



12 COLOURS

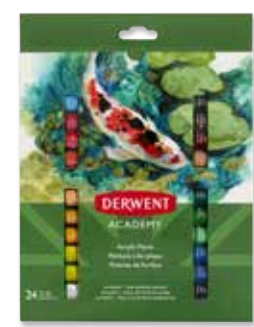

24 COLOURS

ACADEMY OIL PAINTS

Derwent Academy oil paints, while slow to dry, are one of the most versatile forms of painting. Place selected oil colours onto your palette or apply directly to your surface. Remember to always put the cap back on your oil tubes!

RANGE FEATURES

- 24, 12ml tubes of oil paint
- Made from rich pigments and a formulation that retains vibrancy whether used alone or mixed with other painting mediums
- Long drying time allows for colours to be blended over a long period



2302406

98224



12 COLOURS



24 COLOURS

Explore our range of Academy painting sets in oil, acrylic and watercolour. Made from rich pigments and formulations which retain colour vibrancy.

ACADEMY WATERCOLOUR PAINTS

Derwent Academy watercolours are available in a convenient pan set or tubes of paint. Great for creating brilliant washes of even transparent colour.

RANGE FEATURES

- 24, 12ml tubes of watercolours
- Made from rich pigments and a formulation that is easy to use
- Use straight from the tube or dilute with water to achieve various effects



2302404

98222



12 COLOURS



24 COLOURS

ACADEMY WATERCOLOUR PAN SET

RANGE FEATURES

- 12 full-size pans of paint
- Includes a paintbrush
- 3 section lid for easy mixing



2301955



12 COLOURS



With a vibrant and extensive range of markers, Derwent Academy offers flexibility to experiment between fine detail pieces, watercolour wash techniques and fun craft or journalling projects.

1. ACADEMY TWIN-TIP MARKERS

RANGE FEATURES

- 8 vibrant colours
- The chisel tip can be used for freeform drawing as well as calligraphy
- The brush tip creates both thick and thin lines with one stroke
- The fine tip has a broad edge and fine point for maximum control



98206



98208



2. ACADEMY WATER-SOLUBLE MARKERS

RANGE FEATURES

- 20 water-based colours
- Fine tip
- Vibrant, colourful markers contain water-based inks that can be used with water-wash techniques to create a broad range of drawing styles
- Suitable for use as dry or wet drawing media



98202



3. ACADEMY METALLIC MARKERS

RANGE FEATURES

- 8 shimmering colours
- Perfect for drawing, decorating and journalling
- Works well on black paper



98212





DERWENT

DRAWN TO PERFECTION

LAKELAND

DERWENT

DRAWN TO PERFECTION

OFFICE ESSENTIALS

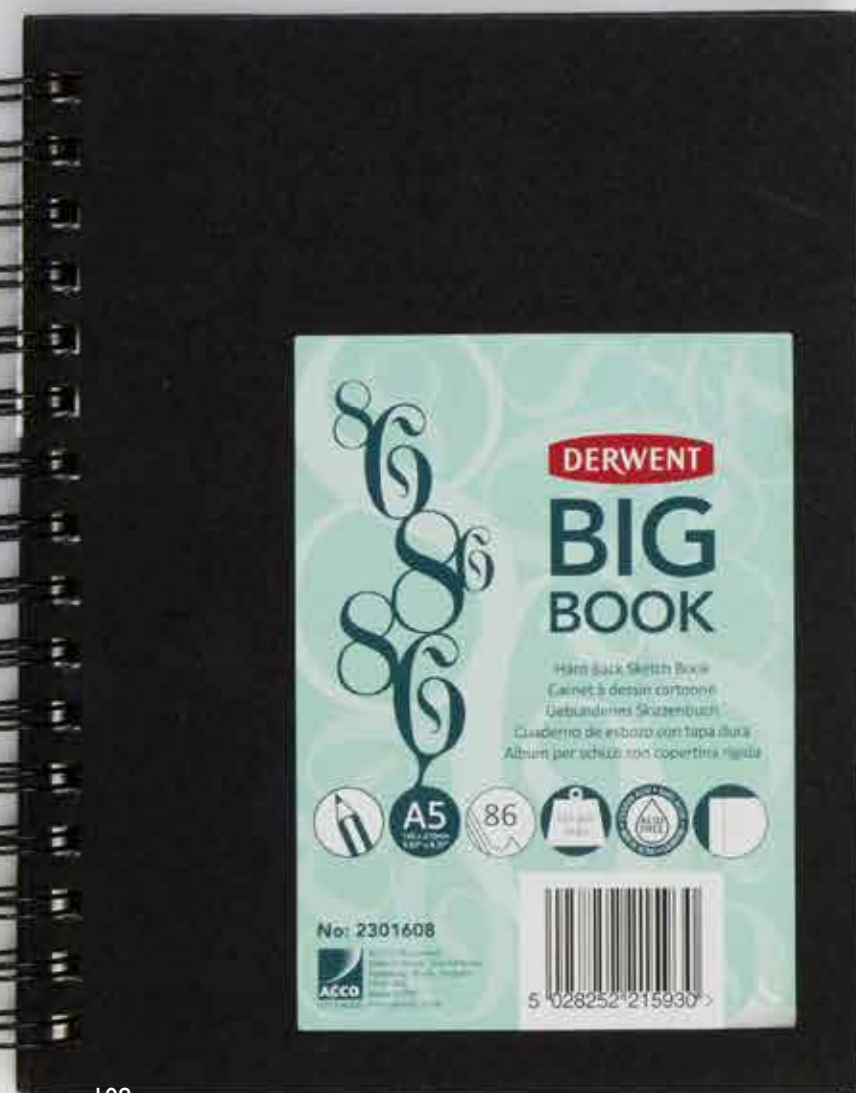
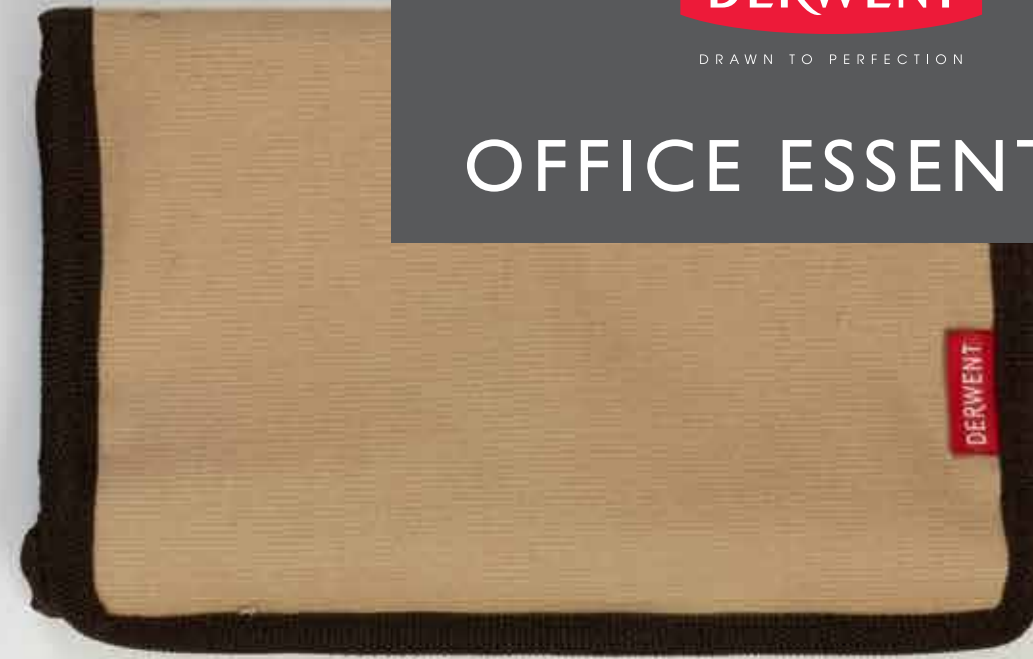

There are an array of Derwent products ideal for practical use in the home, office or school.



1. BIG BOOKS

These wirebound sketchbooks have a bumper stack of 86 perforated sheets, ideal for sketching, drawing or taking notes. Featuring 110gsm (75lbs) acid free paper and a hard wearing black vinyl cover, the range is available in A4 and A5 sizes.

2301607 A4 Portrait
2301608 A5 Portrait

3. SUPER POINT MANUAL HELICAL SHARPENER

Designed to sharpen pencils to the optimum super fine point. Extendable front plate features self feeding mechanism which stops when a superb point has been achieved and no further sharpening is required. For pencils up to 8mm in diameter. Includes sliding tray reservoir and desk clamp. Available individually, box packed.

2302001 Super Point Manual Helical Sharpener
2302000 Super Point Mini Manual Helical Sharpener

*Large (9-12mm)/Small (6-8mm)

2. MANUAL TWIN HOLE SHARPENER

Sharpens both large and small diameter pencils* with shavings neatly caught in a transparent reservoir. Lockable cap prevents shavings spilling out. Available individually in hanging bags.

2301930

4. METAL PENCIL SHARPENER

Designed to fit all Derwent ranges. Sharpens pencils to a fine point. Available in CTU trade packs of 20.

0700233

5. PLASTIC ERASER

Cleanly removes areas of graphite or unwanted marks. Well defined corners and edges give total control and can be re-cut with a sharp knife. Available individually, loose packed.

0700232

6. ARTPACK

Durable canvas case featuring mesh and transparent zipped pockets. Hold 20 pencils. Available individually in hanging bag.

2300575

7. PRECISION MECHANICAL PENCIL

Derwent Precision mechanical pencils have a premium full metal body, perfect for maintaining grip and balance. Ideal for sketching and drawing, the 0.5mm and 0.7mm sets contain 1 mechanical pencil, a refill pack of 15 HB leads and 3 replacement erasers. The graphite leads have a strong point for extended use and minimal breaking. Up to five leads can be placed into the pencil barrel at one time. The smooth laydown of graphite makes the pencil perfect for fine detail and cross hatching techniques. Refillable leads and erasers are available separately.

2302428 Precision HB 0.5 Blister Set
2302430 Precision 0.5 Refill Blister Set
2302429 Precision HB 0.7 Blister Set
2302431 Precision 0.7 Refill Blister Set



High quality HB pencils for the office and classroom. Available as eraser tipped option and in packs of up to 1440 pencils.

REXEL OFFICE PENCILS



- 34253A Rexel Office HB 12 Pencils
- 34251A Rexel Office HB 144 Pencils
- 34264A Rexel Office HB Eraser Tipped 12 Pencils
- 34252A Rexel Office HB Eraser Tipped 144 Pencils
- 2101403 Rexel Office HB School Room 720 Pack
- 2101404 Rexel Office HB Stock Room 1440 Pack

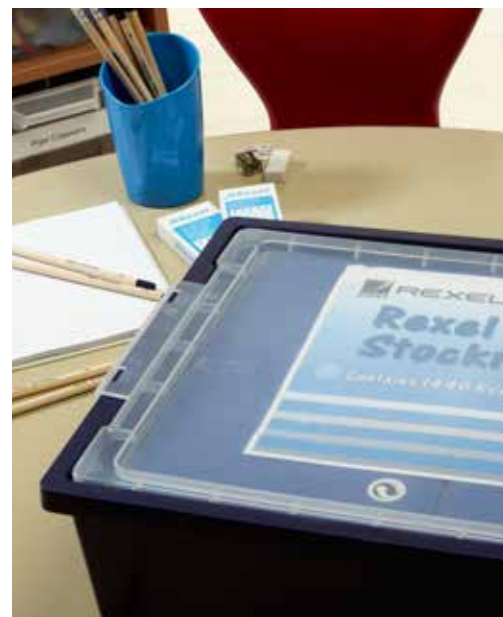

Whether you are a professional joiner or carpenter, or just enjoy doing a bit of DIY at the weekends, this pencil is perfect for the job in hand.

REXEL BLACKEDGE CARPENTERS PENCILS



- 34328 Blackedge Carpenters Pencils Soft 12 Hanging Pack
- 34320 Blackedge Carpenters Pencils Soft 72 Box
- 34330 Blackedge Carpenters Pencils Medium 12 Hanging Pack
- 34322 Blackedge Carpenters Pencils Medium 72 Box
- 34332 Blackedge Carpenters Pencils Hard 12 Hanging Pack
- 34324 Blackedge Carpenters Pencils Hard 72 Box
- 34326 Blackedge Carpenters Pencils Assorted 12 Hanging Pack



DRAWN TO PERFECTION

MERCHANDISING SOLUTIONS



DRAWN TO PERFECTION

PASTEL PENCILS



DRAWN TO PERFECTION

LIGHTFAST

100% Lightfast, Oil-Based, opaque coloured pencils

- 100% Lightfast, all colours comply with ASTM D4303
- Maintains permanent, vibrant colour for years
- Oil-Based, opaque and dense colour application
- Blends like an oil pastel, ideal for use with blending mediums
- Range of 72 vibrant colours
- Available in tins



DRAWN TO PERFECTION

PASTEL PENCILS

- Highly pigmented fine chalk pastel
- Naturally wear-resistant
- Minimal dusting
- Highly lightfast
- Soft texture, easy to blend and layer
- Range of 72 colours
- Available in tins



DRAWN TO PERFECTION

PASTEL PENCILS



FREE STANDING UNITS (FSUs)

A modern modular merchandising solution to show Derwent as a stand out premium brand in retail stores.

Easily adaptable to suit different stock and store environments, the system allows easy category navigation for consumers and an engaging experience at the shelf edge.

Merchandise the FSU using a range of shelves, hooks and point of display (POD) options to showcase a selection of tins, blisters and loose stock.

The Derwent FSU is packed in three clearly marked outer boxes for transit and features standard British AC power plugs. Please source suitable electrical adapters for your region.

POINT OF DISPLAY UNITS (PODs)

All PODs can be fixed to our FSU using the pegboard attachments included (also available separately), or used as stand-alone counter displays.

Product information panels provide detail of product features and benefits of each range. Test and try pads are also positioned on each display (refills available separately 2302759).



1. FREE STANDING UNIT
2302533
2. CATEGORY HEADERS PACK
(inc. 2 plastic headers, magnetic tape and 10 printed headers)
2302601
3. 120MM DISPLAY HOOK
2302540
4. 210MM DISPLAY HOOK
2302539
5. 220MM LOGO DISPLAY HOOK
2302538
6. 12 TIN HOLDER (HOLDS 7 TINS)
2302534
7. 24 TIN HOLDER (HOLDS 7 TINS)
2302535
8. 36 TIN HOLDER (HOLDS 7 TINS)
2302536
9. 72 TIN HOLDER (HOLDS 4 TINS)
2302537
10. 425MM OAK TRAY SHELF
2302546
11. 425MM SHELF WITH PUSH FEEDER
2302542
12. 750MM SHELF WITH PUSH FEEDER
2302543
13. 425MM ANGLED SHELF
2302541
14. 425MM TRAY SHELF
2302545
15. OAK SURROUND AND ILLUMINATION
2302544

1999mm(h)



15.

14.

427mm(w)

396mm(d)



120 POD



422(w) x 193(d) x 709(h)mm

ARTISTS 120 POD: 2302561
STOCK PACK: 2301981
(inc. 1 trade pack of 6 for 120 colours)

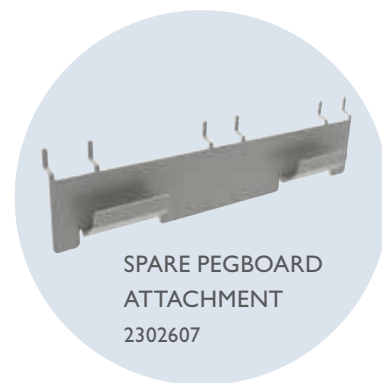

SPARE PEGBOARD
ATTACHMENT
2302607

72 POD



422(w) x 193(d) x 672(h)mm

LIGHTFAST 72 POD: 2302730
STOCK PACK: 2302725
(inc. 2 trade packs of 6 for 36 colours)
PROCOLOUR 72 POD: 302553
STOCK PACK 2302514
(inc. 1 trade pack of 6 for 72 colours)

COLOURSOFT 72 POD: 2302566
STOCK PACK: 0701035
(inc. 1 trade pack of 6 for 72 colours)

STUDIO 72 POD: 2302563
STOCK PACK: 2301982
(inc. 1 trade pack of 6 for 72 colours)

PASTEL 72 POD: 2302568
STOCK PACK: 2300340
(inc. 1 trade pack of 6 for 72 colours)

WATERCOLOUR 72 POD: 2302559
STOCK PACK: 2300179
(inc. 1 trade pack of 6 for 72 colours)

INKTENSE PENCILS 72 POD: 2302555
STOCK PACK: 2301915
(inc. 1 trade pack of 6 for 72 colours)

INKTENSE BLOCKS 72 POD: 2302557
STOCK PACK: 2302036
(inc. 1 trade pack of 6 for 72 colours)

SKETCH & DRAW 72 POD: 2302570
STOCK PACK: 0700768
(inc. 1 trade pack of 6 for 72 colours)



422(w) x 193(d) x 449(h)mm

36 POD



422(w) x 193(d) x 255(h)mm

ARTISTS 36 POD: 2302562
STOCK PACK: 0700862
(inc. 2 trade packs of 6 for 36 colours)

LIGHTFAST 36 POD: 2302729
STOCK PACK: 2302725
(inc. 2 trade packs of 6 for 36 colours)

PROCOLOUR 36 POD: 2302554
STOCK PACK: 2302514
(inc. 2 trade packs of 6 for 36 colours)

COLOURSOFT 36 POD: 2302567
STOCK PACK: 0701039
(inc. 2 trade packs of 6 for 36 colours)

STUDIO 36 POD: 2302564
STOCK PACK: 0700864
(inc. 2 trade packs of 6 for 36 colours)

PASTEL 36 POD: 2302569
STOCK PACK: 0700866
(inc. 2 trade packs of 6 for 36 colours)

WATERCOLOUR 36 POD: 2302560
STOCK PACK: 0700821
(inc. 2 trade packs of 6 for 36 colours)



422(w) x 193(d) x 360(h)mm

24 POD



422(w) x 193(d) x 190(h)mm

INKTENSE PENCILS 36 POD: 2302556
STOCK PACK: 2301917
(inc. 2 trade packs of 6 for 36 colours)

INKTENSE BLOCKS 36 POD: 2302558
STOCK PACK: 2302087
(inc. 2 trade packs of 6 for 36 colours)

SKETCH & DRAW 36 POD: 2302571
STOCK PACK: 0700768
(inc. 2 trade packs of 6 for 36 colours)



422(w) x 193(d) x 190(h)mm

GRAPHITINT 24 POD: 2302572
STOCK PACK: 2301983
(inc. 1 trade pack of 6 for 24 colours)

TINTED CHARCOAL 24 POD: 2302573
STOCK PACK: 2301984
(inc. 1 trade pack of 6 for 24 colours)

DRAWING 24 POD: 2302574
STOCK PACK: 0700830
(inc. 1 trade pack of 6 for 24 colours)



422(w) x 193(d) x 125(h)mm

GRAPHIK LINE PAINTER 24 POD: 2302530
STOCK PACK: 2302516
(inc. 1 trade pack of 6 for 20 colours + waterbrushes)



422(w) x 193(d) x 190(h)mm

METALLIC 12 POD: 2302565
STOCK PACK: 0700473
(inc. 1 trade pack of 6 for 12 colours)

GRAPHIK LINE MAKER 12 POD: 2302531
STOCK PACK: 2302515
(inc. 1 trade pack of 10 for 12 colours)



422(w) x 193(d) x 245(h)mm

XL BLOCKS 12 POD: 2302529
STOCK PACK: 2302520
(inc. 2 trade packs of 6 for 4 colours)





Derwent offers market leading merchandising solutions to help artists understand our range by presenting products and categories clearly and effectively. Providing clean and tidy presentation of the ranges enables artists to choose the right product for their needs.

With an extensive range to choose from, our VIP Programme identifies essential products to stock, merchandise and focus on selling; reducing the full 7m of display required to showcase every product, down to as little as 1.5m to suit the needs of your shop floor and your customers.

Each category has a mixture of innovative, high performance and premium core lines to ensure the ranges have a good level of variation.

ADDITIONAL BENEFITS

By stocking the VIP Programme range and executing to the pre-designed planogram, retailers are rewarded with a host of extra benefits. The more space and range stocked to planogram, the greater the support Derwent can provide.

Supporting POS, external and internal, increased range access, educational workshops and material all increase awareness and understanding of the range – key elements of the VIP Programme.

Incentivised opening stock orders and Derwent funded central promotions will help with the commercial cost of setting up and running the programme.

Call your Sales Representative to find out more.

Family	Range	High Performance	Quality	Reliability	Affordability	Breadth of Range	Popularity	Unique Proposition	Media format	Qty	1.5m	2m	2.5m	3m	3.5m	4m
Colour Pencil	Procolour	•	•							72						
Colour Pencil	Coloursoft	•	•		•		•			36						
Colour Pencil	Lightfast	•	•					•		72						
Colour Pencil	Pastel	•	•				•			36						
Colour Pencil	Inktense		•					•		72						
Water-soluble	Watercolour	•	•			•				36						
Colour Pencil	Studio	•	•	•	•					72						
Water-soluble	Graphitint		•					•	•	24						
Water-soluble	Metallic*	•	•			•				12						
Sketching & Drawing	Tinted Charcoal		•					•	•	24						
Sketching & Drawing	Sketch & Draw		•			•				72						
Pens	Graphik Line Maker*		•			•				12						
Pens	Graphik Line Painter*		•			•				22						
Colour Pencil	Artist	•	•			•				120						
Blocks	Inktense Blocks		•					•	•	72						
Blocks	XL Blocks		•					•	•	36						
Accessories	Accessories		•		•					Asst.						

*Contact your Sales Representative for details of NPD for 2019

When space is limited the range is reduced, ensuring that the most necessary categories are covered with the most compelling and useful consumer ranges.

Increases sales to potentially over **20%** above current levels.



RETAIL FLEXIBILITY

With a range of free standing POS solutions, our Academy merchandising options offer an incremental sales opportunity:

- Prove proposition to trade prior to transition into planogram
- Low cost, value added
- Flexibility and low risk
- Tactical retail execution option for 'Back to School' period
- Seasonal ability outside 'Back to School'



ACADEMY CLIP STRIP
2302758

ACADEMY CTU: 2302757
(example POG pictured)



383(w) x 230(d) x 196(h)mm +147mm (top header)

ALL UNITS COME WITH TRAINING MANUALS INCLUDED

2302754 :ACADEMY FSU
(example POG pictured)



ACADEMY FSU STOCK PACK: 2305517



688(w) x 288(d) x 1580(h)mm +426mm (top header)

Product Description	Qty in Trade Pack	Trade Pack Qty
Derwent Academy Acrylic Paints 12 Pack	6	1
Derwent Academy Oil Paints 12 Pack	6	1
Derwent Academy Watercolour Paints 12 Pack	6	1
Derwent Academy Metallic Markers 8 Pack	8	1
Derwent Academy Twin-Tip Makers – Fine & Brush 8 Pack	8	1
Derwent Academy Soft Pastels 12 Pack	6	1
Derwent Academy Oil Pastels 12 Pack	6	1
Derwent Academy Sketching Pencil 12 Tin	6	1
Derwent Academy Watercolour Pencil 12 Tin	6	1
Derwent Academy Colour Pencil 12 Tin	6	1